

# SINEAX TI 807

## Passive DC signal isolator

without power supply,  
Ex- and non-Ex version, in housing N17 or S17  
for rail and wall mounting

CE 0102  $\text{Ex}$  II (1) G resp. II (2) G

### Application

The signal isolator **SINEAX TI 807** serves to electrically insulate the analogue DC signal in the range 0...20 mA which depending on version is then converted to a current or voltage signal (0...20 mA or 0...10 V). It operates passively and does not require a separate power supply, but derives the little auxiliary energy it needs from the DC signal.

The series of isolators also includes "intrinsically safe" explosion-proof versions with either an intrinsically safe **input** signal [EEx ib] IIC or intrinsically safe **output** signal [EEx ia] IIC. They are thus suitable for use in connection with intrinsically safe equipment installed in the hazardous area.

The signal isolator is supplied in two different housings depending on the number of transmitter channels to be isolated: SINEAX TI 807-5 with **one** transmitter channel to be isolated in housing Type **N17** (Fig. 1) and SINEAX TI 807-1 with **two or three** channels in housing Type **S17** (Fig. 2). Both types of housing are suitable for either rail or wall mounting.

### Features / Benefits

- Electrically insulated analogue DC signals 0...20 mA / Prevents the transfer of interference voltages and currents. Solves grounding problems in meshed signal networks
- Highly accurate / Performs its isolating function with negligible transmission error
- No power supply needed / Saves wiring costs and is easy to install in existing plants
- Available in type of protection "Intrinsic safety" [EEx ib] IIC or [EEx ia] IIC (see "Table 8: Data on explosion protection")
- Snaps onto a DIN rail or screws onto a wall or panel / Adaptable to the circumstances at the place of installation
- Compact and narrow. Housing only 17.5 mm wide / Low space requirement, high packing density. 27 devices fit into a 19" rack

### Layout and mode of operation

The description below refers to SINEAX TI 807-5 with **one** isolation and transmission channel.

The DC signal isolator comprises a DC chopper Z, an isolating stage T, a rectifier G and an oscillator O.

The chopper converts the DC input signal  $E = 0 \dots 20 \text{ mA}$  to an AC signal which is transformed with electrical insulation, rectified, smoothed and appears at the output as a DC **current** signal  $A = 0 \dots 20 \text{ mA}$  (Fig. 3, left). Versions with a DC output **voltage**



Fig. 1. SINEAX TI 807-5 with **one** isolation and transmission channel, in housing **N17**, clipped onto a top-hat rail.



Fig. 2. SINEAX TI 807-1 with **two or three** isolation and transmission channels, in housing **S17**, screw hole mounting brackets pulled out.

signal  $A = 0 \dots 10 \text{ V}$  have a resistive burden of  $500 \Omega$  through which the current flows (Fig. 3, right).

The chopper is controlled by the oscillator which obtains its power from the DC signal.

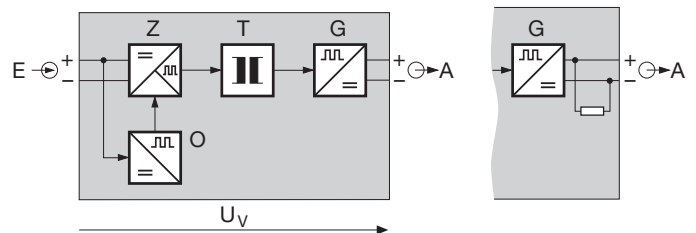

Fig. 3. Block diagram for a function unit.

# SINEAX TI 807

## Passive DC signal isolator

### Technical data

#### Input signal E $\rightarrow$

DC current signal $I_E$ :	0...20 mA
Max. permissible current:	50 mA
Voltage limiter:	Non-Ex version: 27 V $\pm$ 5% (with zener diode) Ex version: 18 V, $\pm$ 5%

#### Output signal A $\leftarrow$

(DC current or DC voltage)

DC current signal  $I_A$ : 0...20 mA

Voltage drop  $U_V$ :

< 2.6 V	with standard (non-Ex) version
< 4.5 V	with Ex versions (input signal(s) "intrinsically safe")
< 6.1 V	with Ex versions (output signal(s) "intrinsically safe")

Max. burden:

1000 $\Omega$	with standard (non-Ex) version
500 $\Omega$	with Ex versions (input signal(s) "intrinsically safe")
500 $\Omega$	with Ex versions (output signal(s) "intrinsically safe")

Limit: Approx. 40 mA

Residual ripple: < 20 mV ss

Time constant: Approx. 3 ms

Response time<sup>1</sup>  
acc. to IEC 770: Approx. 15 ms

DC voltage signal  $U_A$ : 0...10 V

Voltage drop  $U_V$ :

< 2.6 V	with standard (non-Ex) version
< 4.5 V	with Ex versions (input signal(s) "intrinsically safe")
< 6.1 V	with Ex versions (output signal(s) "intrinsically safe")

Internal resistance: 500  $\Omega$

Limit:

< 26 V	with standard (non-Ex) version
< 16 V	with Ex versions (input signal(s) "intrinsically safe")
< 16 V	with Ex versions (output signal(s) "intrinsically safe")

Residual ripple: < 20 mV ss

Time constant: Approx. 3 ms

Response time<sup>1</sup>  
acc. to IEC 770: Approx. 15 ms

### Accuracy data

Error limits:	< $\pm$ 0.1% (Reference value 20 mA of output signal, typical linearity error included)
	< $\pm$ 0.2% (Reference value 10 V of output signal, typical linearity error included)

### Reference conditions

DC current signal $I_E$ :	0...20 mA
Ambient temperature:	23 °C $\pm$ 1 K
Output burden:	250 $\Omega$ (at DC <b>current</b> output signal) $\geq$ 5 M $\Omega$ (at DC <b>voltage</b> output signal)

### Additional error

Burden influence:	< 0.05% / 100 $\Omega$ (at DC <b>current</b> output signal)
Temperature coefficient:	< 50 ppm/K

### Installation data

Mechanical design:	Housing N17 or housing S17 Dimensions see section "Dimensional drawings"
Material of housing:	Lexan 940 (polycarbonate). Flammability Class V-0 acc. to UL 94, self-extinguishing, non-dripping, free of halogen
Mounting:	Snapping onto top-hat rail 35 $\times$ 7.5 or 35 $\times$ 15 mm (acc. to EN 50 022) or directly onto a wall with 2 screws and – adapter (for TI 807-5....) – pull-out screw hole brackets (for TI 807-1....)
Mounting position:	Any
Electrical connections:	Screw terminals with wire guards for light PVC wiring and max. 2 $\times$ 0.75 mm <sup>2</sup> or 1 $\times$ 2.5 mm <sup>2</sup>

<sup>1</sup> This is the time which transpires before the output signal reaches the error limit of 1% for a step change of the input signal from 0  $\rightarrow$  90%.

Weight:

approx. 100 g	TI 807-5.... (housing N17)
approx. 180 g	TI 807-1.... (housing S17) with 2 isolation and transmission channels
approx. 200 g	TI 807-1.... (housing S17) with 3 isolation and transmission channels

## Regulations

Test voltage kV, 50 Hz, 1 min.:

<b>4.0 kV</b>	TI 807-5.... (housing N17) standard (non-Ex) version	Input versus output
<b>2.3 kV</b>	TI 807-5.... (housing N17) Ex versions (input or output signal "intrinsically safe")	
<b>2.3 kV</b>	TI 807-1.... (housing S17) non-Ex <b>and</b> Ex versions (input or output signals "intrinsically safe")	Inputs versus outputs Inputs versus inputs Outputs versus outputs

Surge voltage kV, 1.2/50 µs:

<b>5.0 kV</b>	TI 807-5.... (housing N17) Standard (non-Ex) version	Input versus output
<b>4.25 kV</b>	TI 807-5.... (housing N17) Ex versions (input or output signal "intrinsically safe")	
<b>4.25 kV</b>	TI 807-1.... (housing S17) non-Ex <b>and</b> Ex-versions (input or output signals "intrinsically safe")	Inputs versus outputs Inputs versus outputs Outputs versus outputs

Electromagnetic compatibility:

The standards DIN EN 50 081-2 and DIN EN 50 082-2 are observed

Intrinsically safe:

Acc. to DIN EN 50 020: 1996-04

Electrical design:

Acc. to IEC 1010 resp. EN 61 010

Contamination level:

2

Overtoltage category:

II

Protection (acc. to IEC 529 resp. EN 60529):

Housing IP 40  
Terminals IP 20

## Ambient conditions

Climatic rating:

Climate class 3Z acc. to VDI/VDE 3540

Operating temperature:

-25 to + 55 °C  
**-20** to + 55 °C  
(for the Ex versions: input or output signal(s) "intrinsically safe")

Storage temperature:

-40 to + 70 °C

Annual mean relative humidity:

≤ 75% standard climatic rating  
≤ 95% improved climatic rating

Seismic test:

5 g, < 200 Hz,  
2 h in each of 3 directions

Shock:

50 g,  
10 shocks in each of 3 directions

## Standard version in housing N17 for rail or wall mounting

The following signal isolator versions are available as standard versions. It is only necessary to quote the **Order No.:**

**Table 1: Instruments in standard (non-Ex) version (input *and* output signal *non intrinsically safe*)**

Description	Climatic rating	Output signal	Order Code	Order No.
Passive <b>DC signal isolator</b> , Standard (non-Ex) version, input signal 0...20 mA, with 1 isolation and transmission channel	standard	0...20 mA	807 – 51100	999 154
		0...10 V	807 – 51110	999 162
	improved	0...20 mA	807 – 51101	999 211
		0...10 V	807 – 51111	999 229

# SINEAX TI 807

## Passive DC signal isolator

**Table 2: Instruments in [EEx ib] IIC version (input signal intrinsically safe)**

Description	Climatic rating	Output signal	Order Code	Order No.
Passive <b>DC signal isolator</b> , [EEx ib] IIC, input signal intrinsically safe 0...20 mA, output signal non intrinsically safe, with 1 isolation and transmission channel	standard	0...20 mA	807 – 52100	999 196
		0...10 V	807 – 52110	999 203
	improved	0...20 mA	807 – 52101	999 253
		0...10 V	807 – 52111	999 261

**Table 3: Instruments in [EEx ia] IIC version (output signal intrinsically safe)**

Description	Climatic rating	Output signal	Order Code	Order No.
Passive <b>DC signal isolator</b> , [EEx ia] IIC, input signal non intrinsically safe 0...20 mA, output signal intrinsically safe, with 1 isolation and transmission channel	standard	0...20 mA	807 – 56100	999 170
		0...10 V	807 – 56110	999 188
	improved	0...20 mA	807 – 56101	999 237
		0...10 V	807 – 56111	999 245

### Standard versions in housing S17 for rail and wall mounting

The following signal isolator versions are available as standard versions. It is only necessary to quote the **Order No.**:

**Table 4: Instruments in standard (non-Ex) version (input and output signal non intrinsically safe)**

Description	Number of channels	Output signal	Order Code	Order No.
Passive <b>DC signal isolator</b> , standard (non-Ex) version, input signal 0...20 mA, standard climatic rating	2 channels	0...20 mA	807 – 11200	995 061
	3 channels	0...20 mA	807 – 11300	996 936
	2 channels	0...10 V	807 – 11220	996 944
	3 channels	0...10 V	807 – 11330	996 952

**Table 5: Instruments in [EEx ib] IIC version (input signal intrinsically safe)**

Description	Number of channels	Output signal	Order Code	Order No.
Passive <b>DC signal isolator</b> , [EEx ib] IIC, input signal intrinsically safe 0...20 mA, output signal non intrinsically safe standard climatic rating	2 channels	0...20 mA	807 – 12200	997 009
	3 channels	0...20 mA	807 – 12300	997 017
	2 channels	0...10 V	807 – 12220	997 025
	3 channels	0...10 V	807 – 12330	997 033

The complete Order Code 807-.... and/or a description should be stated for other versions (see “Table 7: Specification and ordering information”).

**Table 6: Instruments in [EEx ia] IIC version (output signal intrinsically safe)**

Description	Number of channels	Output signal	Order Code	Order No.
Passive <b>DC signal isolator</b> , [EEx ia] IIC, input signal non intrinsically safe 0...20 mA, output signal intrinsically safe standard climatic rating	2 channels	0...20 mA	807 – 16200	996 960
	3 channels	0...20 mA	807 – 16300	996 978
	2 channels	0...10 V	807 – 16220	996 986
	3 channels	0...10 V	807 – 16330	996 994

The complete Order Code 807-.... and/or a description should be stated for other versions (see “Table 7: Specification and ordering information”).

**Table 7: Specification and ordering information** (see also “Tables 1 to 6: Standard versions”)

Order Code <b>807</b> –			
Features, Selection	*SCODE	no-go	
<b>1. Mechanical design</b>			
1) Housing S17	B		1 . . . . .
5) Housing N17	C		5 . . . . .
<b>2. Version</b>			
1) Standard (non-Ex) Input <b>and</b> output signal(s) <b>non intrinsically safe</b>			. 1 . . . . .
2) [EEx ib] IIC, Input signal(s) <b>intrinsically safe</b>			. 2 . . . . .
6) [EEx ia] IIC, Output signal(s) <b>intrinsically safe</b>			. 6 . . . . .
<b>3. Number of isolation and transmission channels</b>			
1) 1 channel (interface)		B	. . 1 . . . . .
2) 2 channels (interfaces)		C	. . 2 . . . . .
3) 3 channels (interfaces)		C	. . 3 . . . . .
Line 1: “1 channel” <b>only</b> available for signal isolators in the housing type <b>N17</b> . Lines 2 and 3: “1 and 3 channels” <b>only</b> available for signal isolators in the housing type <b>S17</b> .			
<b>4. Output signal(s) A or A1 and A2 or A1, A2 and A3</b>			
0) 0 ... 20 mA			. . . 0 . . . . .
1) 0 ... 10 V, 1 channel		B	. . . 1 . . . . .
2) 0 ... 10 V, 2 channels		C	. . . 2 . . . . .
3) 0 ... 10 V, 3 channels		C	. . . 3 . . . . .
<b>5. Climatic rating</b>			
0) Standard climatic rating			. . . . 0 . . . .
1) Improved climatic rating			. . . . 1 . . . .

\* Lines with letter(s) under “no-go” cannot be combined with preceding lines having the same letter under “SCODE”.

# SINEAX TI 807

## Passive DC signal isolator

**Table 8: Data on explosion protection**  **II (2) G resp. II (1) G**

Order Code	Type of protection	Electrical data acc. to Certificates		Type Examination Certificate	Mounting location									
		Input	Output											
807-52...	[EEx ib] IIC	$L_i = 24 \mu\text{H}$ $C_i = 0$ for connection to certified intrinsically safe circuit with the following maximum values: $U_i = 33 \text{ V}$ $I_i = 150 \text{ mA}$	$U_m = 253 \text{ V AC}$ resp. $125 \text{ V DC}$	PTB 97 ATEX 2112	Outside the hazardous area									
807-56...	[EEx ia] IIC	$U_m = 253 \text{ V AC}$ resp. $125 \text{ V DC}$	$U_o = 15.75 \text{ V}$ $I_o = 100 \text{ mA}$ $P_o = 400 \text{ mW}$ linear characteristic											
			<table border="1"> <tr> <td></td> <td>IIC</td> <td>IIB</td> </tr> <tr> <td><math>L_o</math></td> <td>4 mH</td> <td>15 mH</td> </tr> <tr> <td><math>C_o</math></td> <td>478 nF</td> <td>2.88 <math>\mu\text{F}</math></td> </tr> </table>				IIC	IIB	$L_o$	4 mH	15 mH	$C_o$	478 nF	2.88 $\mu\text{F}$
	IIC	IIB												
$L_o$	4 mH	15 mH												
$C_o$	478 nF	2.88 $\mu\text{F}$												
			<table border="1"> <tr> <td></td> <td>IIC</td> <td>IIB</td> </tr> <tr> <td><math>L_o</math></td> <td>4 mH</td> <td>15 mH</td> </tr> <tr> <td><math>C_o</math></td> <td>478 nF</td> <td>2.88 <math>\mu\text{F}</math></td> </tr> </table>		IIC	IIB	$L_o$	4 mH	15 mH	$C_o$	478 nF	2.88 $\mu\text{F}$		
	IIC	IIB												
$L_o$	4 mH	15 mH												
$C_o$	478 nF	2.88 $\mu\text{F}$												
807-12...	[EEx ib] IIC	$L_i = 24 \mu\text{H}$ $C_i = 0$ for connection to certified intrinsically safe circuit with the following maximum values: $U_i = 33 \text{ V}$ $I_i = 150 \text{ mA}$	$U_m = 253 \text{ V AC}$ resp. $125 \text{ V DC}$	PTB 97 ATEX 2102										
807-16...	[EEx ia] IIC	$U_m = 253 \text{ V AC}$ resp. $125 \text{ V DC}$	$U_o = 15.75 \text{ V}$ $I_o = 100 \text{ mA}$ $P_o = 400 \text{ mW}$ linear characteristic											
			<table border="1"> <tr> <td></td> <td>IIC</td> <td>IIB</td> </tr> <tr> <td><math>L_o</math></td> <td>4 mH</td> <td>15 mH</td> </tr> <tr> <td><math>C_o</math></td> <td>478 nF</td> <td>2.88 <math>\mu\text{F}</math></td> </tr> </table>		IIC	IIB	$L_o$	4 mH	15 mH	$C_o$	478 nF	2.88 $\mu\text{F}$		
	IIC	IIB												
$L_o$	4 mH	15 mH												
$C_o$	478 nF	2.88 $\mu\text{F}$												
			<table border="1"> <tr> <td></td> <td>IIC</td> <td>IIB</td> </tr> <tr> <td><math>L_o</math></td> <td>4 mH</td> <td>15 mH</td> </tr> <tr> <td><math>C_o</math></td> <td>478 nF</td> <td>2.88 <math>\mu\text{F}</math></td> </tr> </table>		IIC	IIB	$L_o$	4 mH	15 mH	$C_o$	478 nF	2.88 $\mu\text{F}$		
	IIC	IIB												
$L_o$	4 mH	15 mH												
$C_o$	478 nF	2.88 $\mu\text{F}$												



Contact Esys for more information about this product:  
 Esys® The Energy Control Company™  
 4520 Stine Road, Ste 7  
 Bakersfield, CA 93313  
 (661) 833-1902

email: [esys@esys.us](mailto:esys@esys.us)  
 website: <http://www.esys.us>



## Electrical connections

### Signal isolator in housing *N17* with *one* isolation and transmission channel

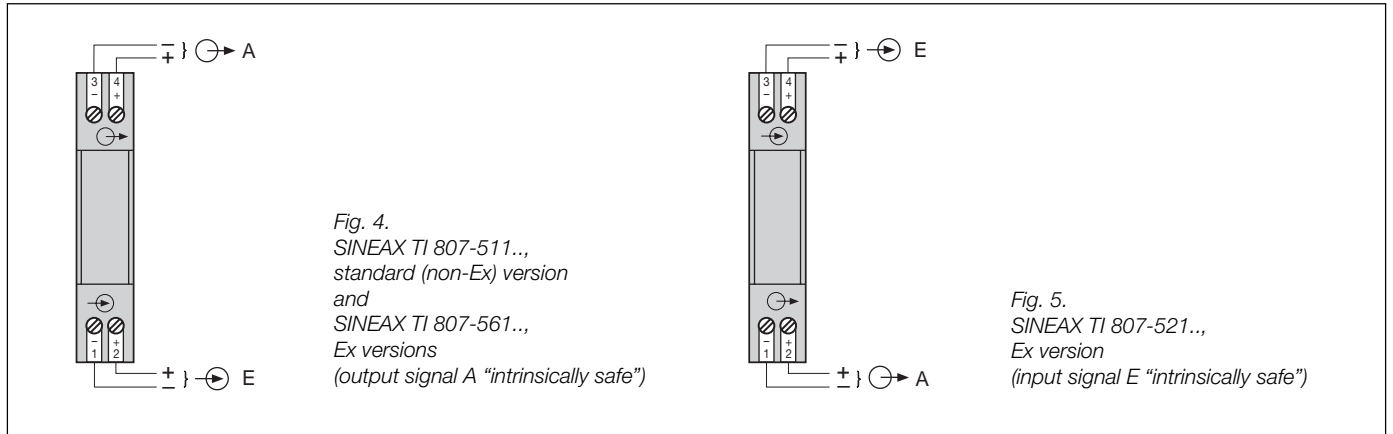

### Signal isolator in housing *S17* with *two* isolation and transmission channels

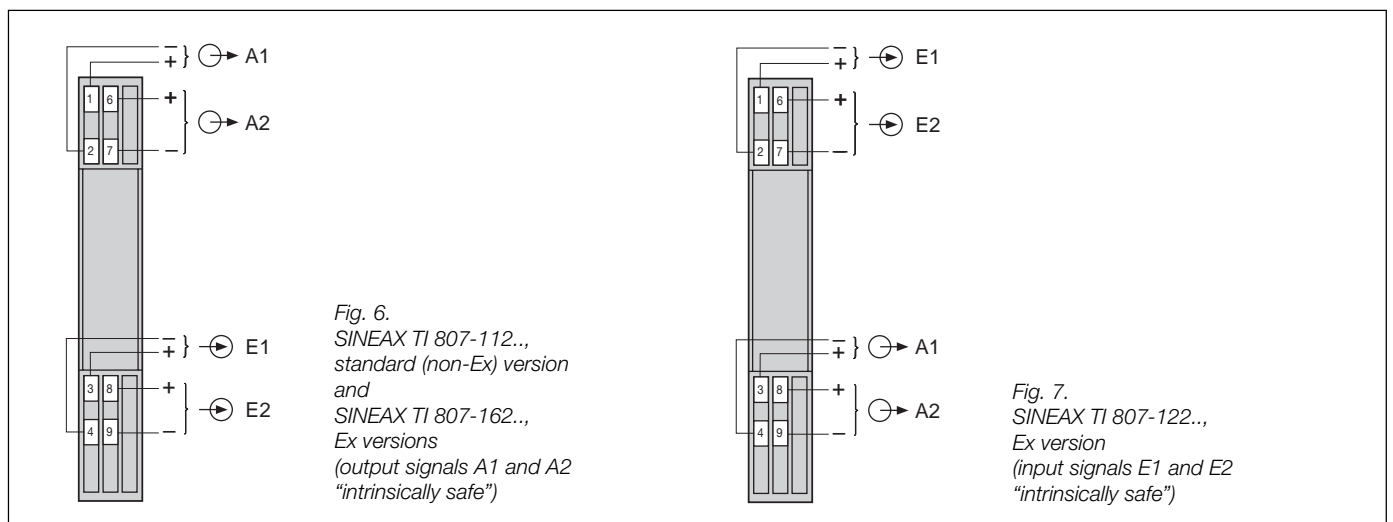

### Signal isolator in housing *S17* with *three* isolation and transmission channels

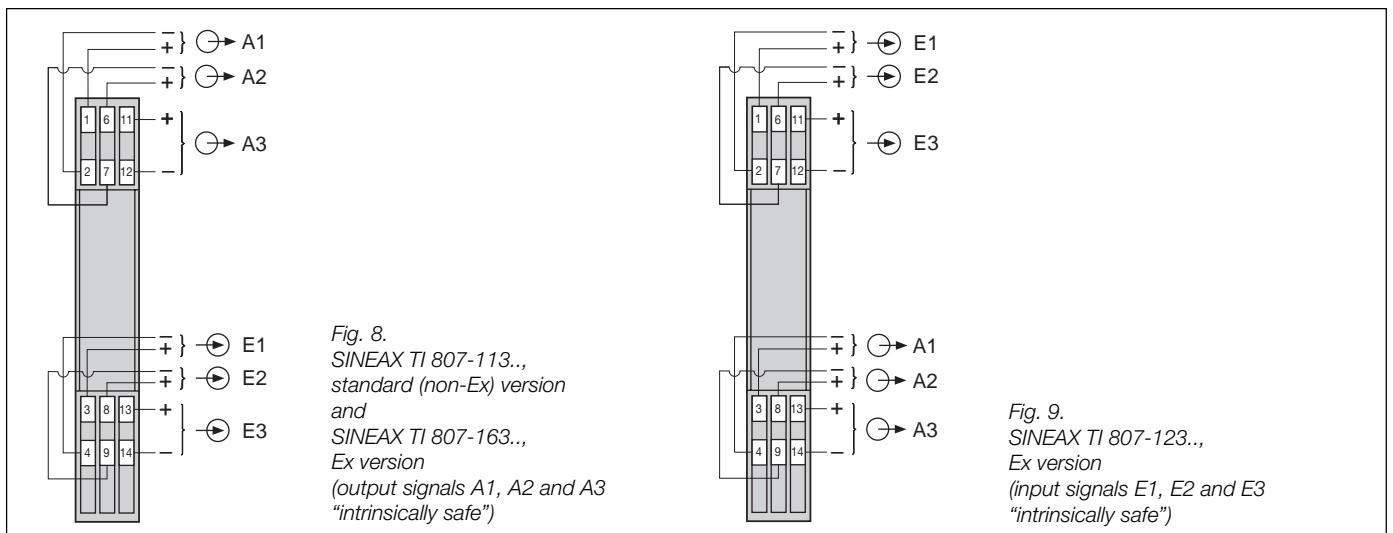

# SINEAX TI 807

## Passive DC signal isolator

### Dimensional drawings

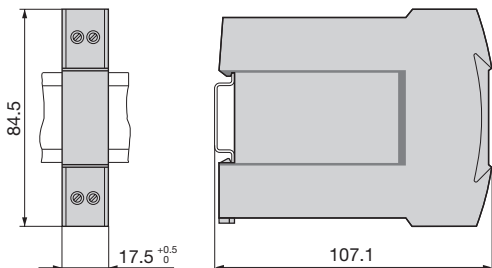

Fig. 10. SINEAX TI 807-5.... (housing **N17**) clipped onto a top-hat rail (35 × 7.5 or 35 × 15 mm, acc. to EN 50 022).

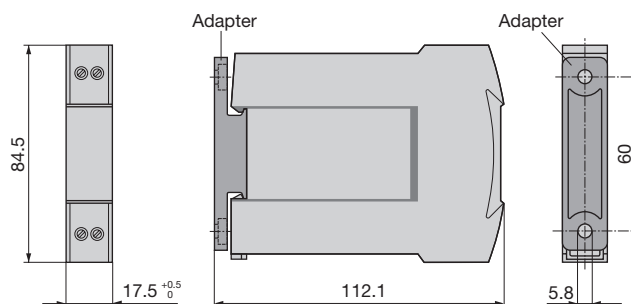

Fig. 11. SINEAX TI 807-5.... (housing **N17**) with adapter for directly wall mounting.

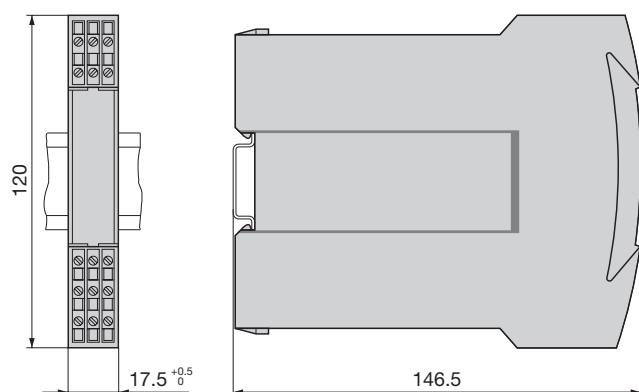

Fig. 12. SINEAX TI 807-1.... (housing **S17**) clipped onto a top-hat rail (35 × 7.5 or 35 × 15 mm, acc. to EN 50 022).

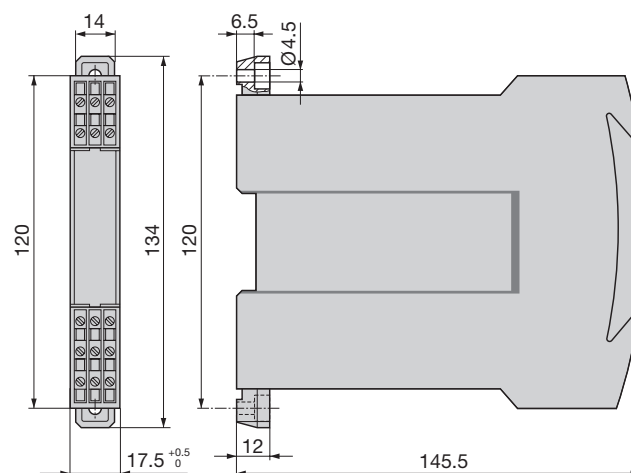

Fig. 13. SINEAX TI 807-1.... (housing **S17**) screw hole mounting brackets pulled out.

### Standard accessories

- 1 Adapter (for signal isolators TI 807-5...., variants in housing type **N17** only)
- 1 Operating Instructions each in German, French and English for SINEAX TI 807-5 in housing type **N17**
- 1 Operating Instructions in three languages: German, French and English for SINEAX TI 807-1 in housing type **S17**
- 1 Type Examination Certificate (for instruments in type of protection "Intrinsically safe" only)