

4 PRINCIPLE OF OPERATION

GreenLine 2000 analyzer is based on the following functional blocks:

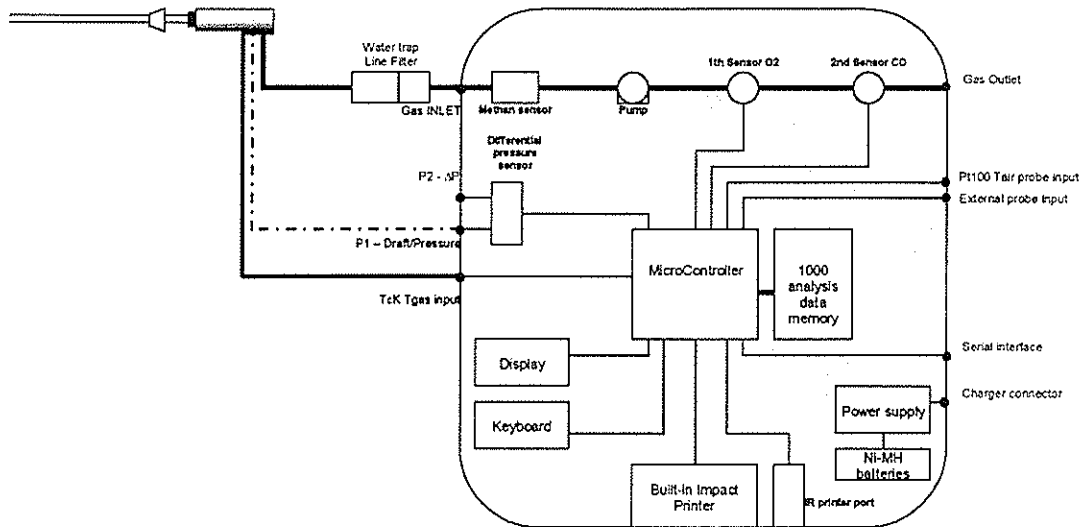

3.1 Measurement principal

The gas is sampled and aspirated through the probe with a primary pump powered at constant voltage. To position the sampling probe in the exhaust gas pathway a hole of 11mm, up to 16mm, should be drilled and the retaining cone of the sampling probe firmly screwed in it.

The retaining screw in the cone enables the probe to be easily moved to locate the core flow, normally correspondent to the centre of the section of the chimney. The flue gas and exhaust gas pathway, should be checked for gas-tightness before carrying out a measurement and, if necessary, non gas-tight points should be sealed. The O₂ sensor is essentially an electrochemical cell, with two electrodes and electrolyte solution. The behaviour is similar to a normal battery and therefore the sensitivity decreases with time.

The electrochemical cell grants accurate results for time intervals of approximately 60 minutes. GreenLine automatically corrects the zero drift every time the instrument is switched-on, using fresh ambient air as reference. This operation should be made with the sampling probe not inserted in the chimney or with the sampling probe pneumatic connector disconnected from the Analyzer gas inlet.

When a long time analysis has to be made, a new autozero procedure should be performed.

Measured and calculated parameters are indicated on a LCD alphanumeric display (40x56 mm), equipped with an automatic back light device for easy readings, also in poor light conditions.

3.1.1 Gas sampling probe

The sampling probe consists of a steel tube and a handle of thermo insulating material. A positioning cone allows placing the probe in holes with a diameter from 11 to 16 mm.

The gas temperature is acquired using a thermocouple type K with the junction placed on the top of the tip.

3.1.2 Water trap & line filter

The gas flows through an external combined water trap and line filter to avoid the presence of condensation and suspended solid particles in the analysis section of the instrument. A cylinder is positioned at 15 cm from the instrument gas inlet it is divided into two parts: the water trap and the line filter.

The **water trap** works using the expansion principle: the gas flow decreases its speed inside the cylinder and it will cool; the humidity will condense and the solid particles fall down. The section of the water trap must be periodically drained off to avoid water from entering the analysis section. Pull the rubber plug (cat. EE650081) and shake slowly the trap to drain the water. Push the rubber plug to close the trap hole.

The **line filter** is positioned after the water trap and before the electrochemical cell. Its function is to stop the smallest solid particles before the analysis. Remember to change the filter (cat. EE650074) every time it is dirty.

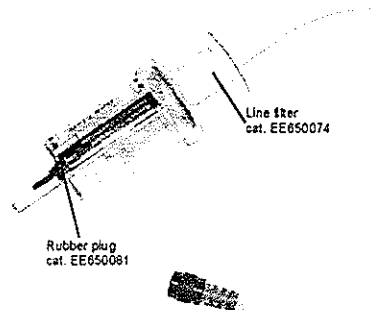
**WARNING**

THE WATER TRAP MUST BE KEPT IN VERTICAL POSITION DURING GAS SAMPLING. AN INCORRECT POSITIONING OF THE TRAP CAN ALLOW THE WATER TO ENTER INSIDE THE ANALYZER AND DAMAGE THE ELECTROCHEMICAL SENSORS.

NEVER MAKE ANY ANALYSIS WITHOUT THE DRAINING RUBBER PLUG. THE MEASUREMENTS WILL BE INCORRECT.

WHEN YOU FINISH THE ANALYSIS, REMEMBER TO DRAIN THE WATER TRAP. BEFORE PUTTING THE GAS PROBE IN THE CARRYING CASE, REMOVE THE CONDENSATE WATER FROM THE PROBE HOSE.

THE LINE FILTER SHOULD BE REPLACED WHEN DIRTY. NEVER MAKE ANY ANALYSIS WITHOUT LINE FILTER AND/OR WATER TRAP, AS IT CAUSES AN IRREVERSIBLE DAMAGE TO THE ELECTROCHEMICAL SENSOR.

3.1.3 Gas sensors

The Analyzer uses long life sensors for O₂ and CO measurements. The gas sensors are electrochemical cells composed by two electrodes (anode and cathode) and an electrolyte solution. The sampled gas goes through a selective diffusion membrane. The oxidation process produces an output electrical signal proportional to the gas concentration. The signal is evaluated by the electronics, converted to digital, processed by the microprocessor, displayed and printed with a 0.1% volume resolution.

The flue gas must not be at a pressure that could damage or destroy the sensor. Measurements are always carried out under "pressure less" conditions. The maximum permissible excess/reduced pressure is ± 100 mbar.

Each sensor has a different response time:

O ₂	= 20s to 90% of reading
CO (H ₂ comp.)	= 50s to 90% of reading
CO	= 50s to 90% of reading

NOTE: TO OBTAIN AN ACCURATE MEASURE IT IS RECOMMENDED TO WAIT 3 TO 5 MINUTES.

If an excessive (>150% of F.S.) gas concentration is applied to toxic gas sensor, then a $\pm 2\%$ drift and a long resuming time can be present. In that case it is recommended to wait for a measured value lower than 20ppm, by sucking fresh air before switching the Analyzer off.

Four acoustic and visual alarm levels can be set on four programmable parameters.

3.2 Auxiliary measurements

3.2.1 Temperature measurements

The instrument is equipped with two temperature inputs to measure exhaust gas and the burner air input temperatures (combustion gas).

- ◆ A thermocouple type K (nickel-nickel chromium) is included in the tip of the gas-sampling probe to measure the flue gas/exhaust gas temperature. This thermocouple is suitable for permanent measurements at temperatures up to 800°C and for short-term measurements up to 1000°C. Temperature measurement and gas sampling from the flue gas pathway is thus always performed at the same site. The probe is connected to the apparatus with compensated cable and connector. An internal Pt100 resistance thermometer is used for cold junction compensation.
- ◆ A remote Pt100 sensor can be supplied on request with a 2-meter cable to measure the air inlet temperature in forced air boiler. This option is very important for an accurate efficiency calculation.

3.2.2 Pressure and Draft

The analyzer is equipped with a temperature compensated pressure sensor to measure the chimney draught or pressure. The pressure/draught sensor is based on the principle of the extension metric measuring bridge. The pressure range is ± 1000.0 mmwc (± 100.00 hPa). The sensor is factory calibrated and does not require manual adjustment. The zero drift, caused by ambient air temperature variation, is automatically cancelled at each instrument start-up. In addition, for more accurate readings the operator can reset, using the pertinent key, the zero if required. Leave open the "ΔP" connector during this phase.

NOTE: WE SUGGEST EXECUTING THE AUTOZERO PROCEDURE FOR MORE ACCURACY BEFORE PERFORMING THE MEASUREMENT.

CAUTION

IF A SINGLE TUBE GAS SAMPLING PROBE IS USED FOR PRESSURE/DRAFT MEASUREMENTS, BE SURE THAT IT IS CLEAN AND DRIED BEFORE CONNECTING TO THE PRESSURE INPUT.

CAUTION

A +300hPA (OR -300hPA) OVER-PRESSURE CAN PERMANENTLY DAMAGE THE PRESSURE SENSOR.

3.2.3 Smoke index measurement (optional)

This method consists of taking a gas sample from the centre of the gas pipe behind the heat exchanger and crossing it through a special filter paper.

The colour of the spot on the filter is compared with a graduated (from 0 to 9) reference scale and it is called "smoke index".

You can type in **GreenLine** up to 3 smoke index values; the analyzer calculates the average value and prints these values on the report.

Normative and laws about the air pollution, describes the procedure: DIN51402, 2116, 2117 and 2297 VDI directives, ASTM D 2156-63 T, etc.

3.2.3.1 Measuring instruments (optional)

1. **Smoke pump:** it should suck 1.63 litres ± 0.07 l (normalized to 0°C, 760mmHg) through a 1 cm² filter.
2. **Smoke index reference table:** it is a grey scale sheet with 10 different areas numbered from 0 to 9. The number 0 corresponds to an 85% $\pm 2.5\%$ reflection. Every area reflects 10% less than the previous one. The scale is used to compare the scale with the paper filter and to calculate the smoke index.
3. **Paper filter:** When it is clean it has a reflection corresponding to the 0 scale index. It also has 3 litres per cm² a minute (normalized to 0°C, 760mmHg) with a 200/800 mmwc resistance to the air flux.

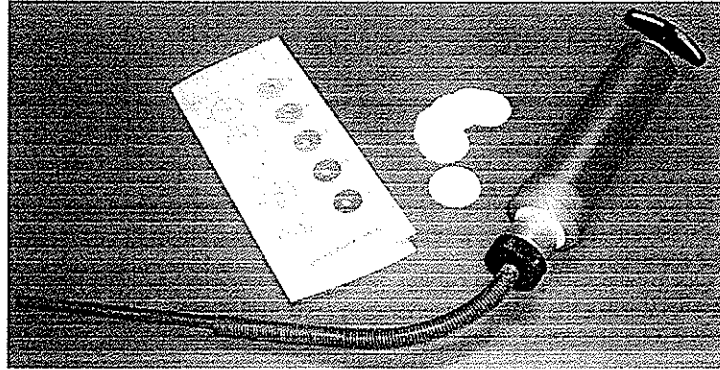

3.2.4 Other measurements

The analyzer has an auxiliary input for special probes connections. Available probes are: ambient CO monitoring and natural gas monitoring probes.

An optional operative mode is the leakage pipe test to check gas network tightness using pressure decay method at programmable interval time.



4 RECOMMENDATIONS

- The analyzer should be used in environments where the temperature is between -5°C and +45°C.
- When the analysis is completed, before switch the instrument off, remove the probe from the gas pathway and wait about 30 seconds cleaning the pneumatic circuit from gas.
- Do not use the analyzer with clogged filters or filled with humidity.
- Before placing the probe in the case, be sure that the probe, the water trap and the hose are clean and cold.
- If you have ordered a double hose sampling probe, insert both connectors to the instrument during the gas analysis (pay attention to color correspondence).
- To empty the water trap from the condensate water, remove the draining plug. DO NOT OPEN the water trap. DO NOT leave the water trap without the draining rubber plug (cat. EE650081).
- For the best efficiency and accuracy, we suggest calibrating the instrument every year.

WARNING

IF THE GREENLINE IS STORED AT TEMPERATURE EXCEEDING THE OPERATIVE LIMITS, THE ANALYZER NEEDS SOME MINUTES TO WARM-UP TO THE ACTUAL AMBIENT TEMPERATURE, BEFORE STARTING THE OPERATION.

4.1 Power supply

GreenLine can be powered from:

- Internal rechargeable Ni-MH battery.
- External battery charger, supplied as a standard accessory (the batteries must be installed).
- Optional external DC auto battery charger (the batteries must be installed).

The Ni-MH rechargeable batteries allows a long time operation and do not need maintenance. The same batteries power both the instrument and the internal printer. The internal battery will grant 6 hours continuous operation (without printing and display back light off).

NOTE: 90% BATTERY CHARGING CAN BE OBTAINED IN 8 HOURS WITH GREENLINE SWITCHED OFF.

During operation a fully battery symbol "≠" will be displayed on the display. This symbol means that the batteries are completely full. When the batteries will be discharged the symbol "-" will appear and the instrument still has about 20 minutes operation capability to end the running analysis.

The battery symbol indicates that a full charge is required. Use only the dedicated battery charger supplied by Eurotron together the instrument.

CAUTION: OLD BATTERIES CAN LEAK AND CAUSE CORROSION. NEVER LEAVE RUN DOWN BATTERIES IN THE INSTRUMENT

WARNING

THE INSTRUMENT IS SHIPPED WITH AN AVERAGE LEVEL OF BATTERY CHARGE. AFTER UNPACKING, A FULL CHARGE OF THE BATTERY IS RECOMMENDED, BY CONNECTING THE INSTRUMENT TO THE MAIN LINE THROUGH THE BATTERY CHARGER (OFF CONDITION) FOR 8/10 HOURS.

5 CONNECTIONS

5.1 Electro-pneumatic connections

To prepare the instrument for operation, connect the sampling probe to the instrument:

- Plug the pneumatic connector of the probe to the GAS INLET connector. If you are using the gas-sampling probe with Draft option (double hose model), connect also the draft connector to the GreenLine Pressure/Draft inlet (P1).
- Plug the probe temperature sensor plug to the pertinent connector.
- If necessary, plug the remote air temperature Pt100 sensor to the pertinent connector.

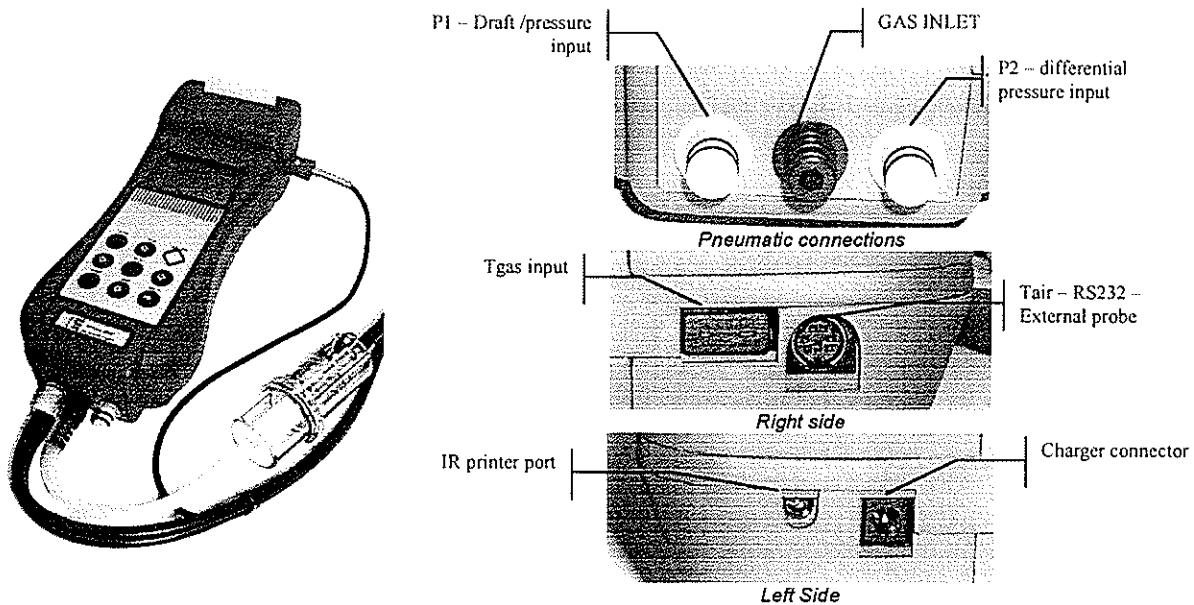

WARNING

BEFORE STARTING THE GAS ANALYSIS PROCEDURE BE SURE THAT:
 PROBE DRAFT CONNECTOR (P1) AND GAS SAMPLING CONNECTOR (INLET) ARE PLUGGED TO THE INSTRUMENT;
 DRAINING PLUG IS WELL INSERTED IN THE WATER TRAP;
 LINE FILTER IS CLEAN.

6.2 Gas probe positioning

The measurement site should be arranged at a distance of $2xD$ behind the exhaust gas connection pipe, where D = diameter of the exhaust gas connection pipe.

To position the sampling probe in the exhaust gas pathway a hole of 11/16mm should be drilled and the retaining cone of the sampling probe firmly screwed in it.

The retaining screw in the cone enables the probe to be easily moved in order to locate the core flow, normally correspondent to the centre of the section of the stack.

The flue gas and exhaust gas pathways must be checked for gas-tightness before carrying out a measurement and, if necessary, non gas-tight points should be sealed.

To locate the gas core flow insert progressively the sampling probe and read the maximum value of temperature.

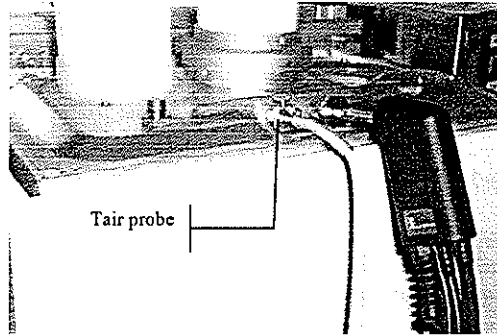

CAUTION

FOR A CORRECT GAS ANALYSIS, NO AIR MUST REACH THE FLUE GAS AS A RESULT OF NON-GAS-TIGHT CONNECTION POINTS BETWEEN THE HEAT PRODUCER AND THE MEASUREMENT SITE (PROBE).

THE FLUE GAS AND EXHAUST GAS PATHWAYS MUST BE CHECKED FOR GAS-TIGHTNESS BEFORE CARRYING OUT A MEASUREMENT, AND IF NECESSARY NON-GAS-TIGHT POINTS SHOULD BE SEALED.

6 OPERATIONS

All the procedures and programming operations on **GreenLine 2000** can be made using the keyboard and the display.

NOTE: ALL NUMERIC VALUES SHOWN IN THE FIGURES OF THIS MANUAL ARE INDICATIVE AND LISTED AS AN EXAMPLE.

The analyzer should be used in environments where the temperature does not exceed the specified limits (from -5°C to +45°C) and where the relative humidity is lower than 95% non-condensing.

6.1 Flue gas analysis

6.1.1 Switch the instrument ON

- Connect the gas probe to the analyzer as shown in chapter 6. **DO NOT INSERT THE PROBE IN THE CHIMNEY.**
- Switch the analyzer on pressing the [ON] key. The display will show the following page:

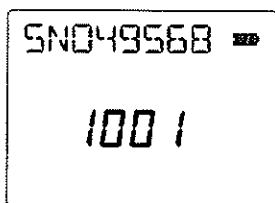

This page changes automatically after some seconds or if you press a key as follows:

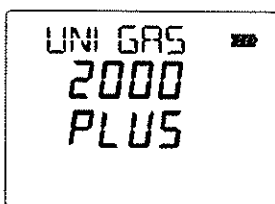

This page changes automatically after some seconds or if you press a key as follows:

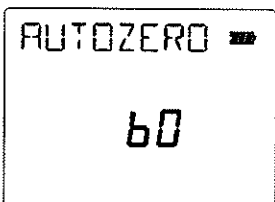

This page displays the seconds to end the autozero procedure.

NOTE: THE ANALYZER MUST DRAW CLEAN AIR FROM THE AMBIENT DURING THE AUTOZERO PROCEDURE. OTHERWISE THE MEASUREMENTS CANNOT BE ACCURATE AND A SENSOR ERROR MAY OCCUR.

When autozero procedure finishes, and no error occurs, an intermittent sound advises the operator. Autozero time interval is standard set to 60 seconds. If one or more sensors have a problem, GreenLine will perform another autozero procedure.

- Press the [ENTER] key to mute the unit. The following page will be displayed:

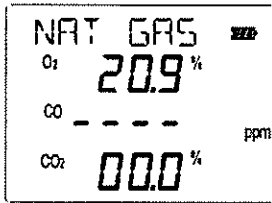

- GreenLine 2000 is now ready for the flue gas analysis.

NOTE: AFTER THE INSTRUMENT IS SWITCHED ON, ALL SETTINGS WILL BE AS THE PREVIOUS SWITCHING OFF.

6.1.2 Flue Gas Analysis

- Insert the probe in the chimney. Stop using the retaining cone and adjust the immersion depth for a gas sampling in the middle of the exhaust gas connection pipe.
- Plug the pneumatic connector of the probe to the GAS INLET connector. If you are using the gas sampling probe with Draft option (double hose model), connect also the draft connector to the GreenLine Pressure/Draft inlet (P1).
- Plug the temperature sensor of the sampling probe to the pertinent TcK connector.
- If necessary, plug the remote air temperature Pt100 probe to the pertinent connector. It is important to measure the true combustion air temperature to have a correct boiler efficiency computation. GreenLine has an auxiliary Rtd input to measure simultaneously the air temperature. A Pt100 with a 2 meters long cable can be connected on the right side of the analyzer. Insert the Rtd inside the air combustion aspiration tube and near the boiler. The GreenLine will show the temperature on the display and the efficiency will be calculated using this value. If no external Rtd is connected, the analyzer will measure the instrument temperature (ambient) using the internal sensor.

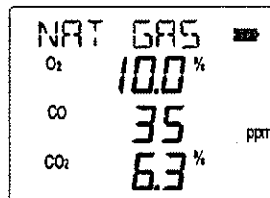
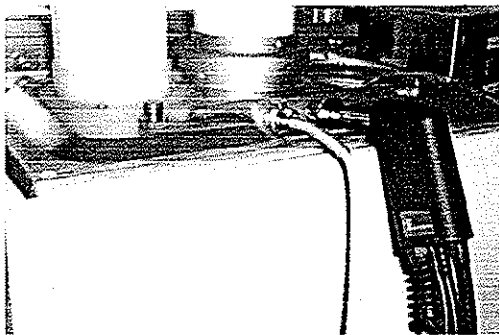

Pressing the [◀] and [▶] keys you can change page to display others parameters

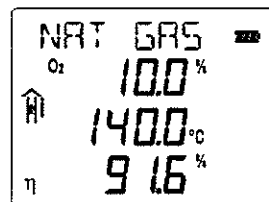
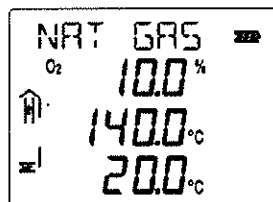
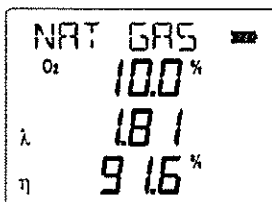

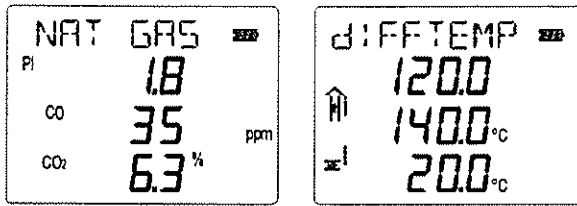

Pressing the [REF. O₂] key the measured parameters will be referred to the programmed oxygen value. When selecting this mode, the message "REF O₂CO" will be displayed.

6.1.3 Fuel type set-up

If the displayed fuel type does not coincide with your necessity, you should proceed as follow:

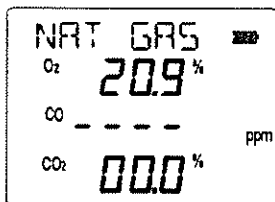

- Press the [MENU] key until the following page will be displayed:

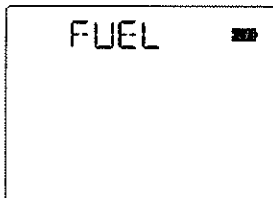

- Press the [ENTER] key to change the fuel type.



- Use the [▲] and [▼] keys to change the fuel type (standard available types are: LPG, Light oil, Oil, Town gas.

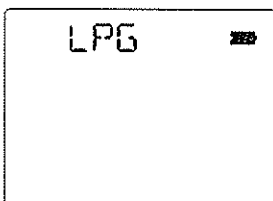

- Press the [ENTER] key to store the value.

- Press [ESC] to return to the measure page.

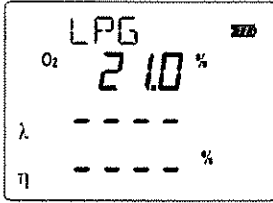

6.1.4 Pressure/Draft measurements

GreenLine 2000 has an internal differential pressure sensor installed. With this sensor, you can execute the pressure/draft measurements by using of the standard probe or the special probe.

Standard single hose probe (TG models):

The standard probe has one gas collector for gas sampling. Usually you have the hose terminal connected to the GreenLine gas inlet; when you have to do the draft measurements you have to move the connector to pressure inlet (INLET) connector.

Special dual hose probe (TGD models):

This special probe model has two gas collectors: one for the flue gas analysis and one for the draft measurement. When you connect the probe to the Analyzer you have to insert both gas inlet (INLET) and pressure inlet (P1) connectors. Connect the hose with line filter to gas inlet connector.

CAUTION

IF A SINGLE TUBE GAS SAMPLING PROBE (TG MODEL) IS USED FOR PRESSURE/DRAFT MEASUREMENTS, BE SURE THAT PROBE AND HOSE ARE CLEAN AND DRY BEFORE CONNECTING TO THE PRESSURE INPUT.

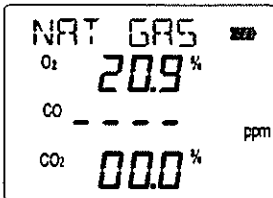

- Press the [MENU] key until the following page will be displayed:

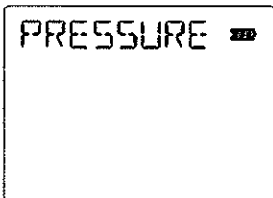

- Press the [ENTER] key to show the following page. The internal pump will stop.

NOTA: DO NOT INSERT THE PROBE IN THE CHIMNEY.

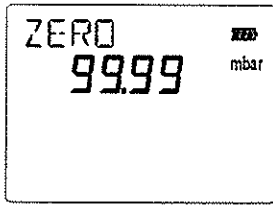

- Press the [ENTER] key before insert the probe in the chimney to zeroing the measured value.

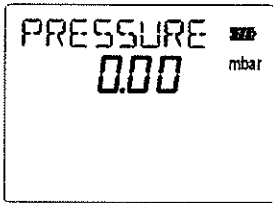

- Insert the probe in the chimney. Check for mechanical positioning and flue gas intercepting. Wait for measurement stabilization.

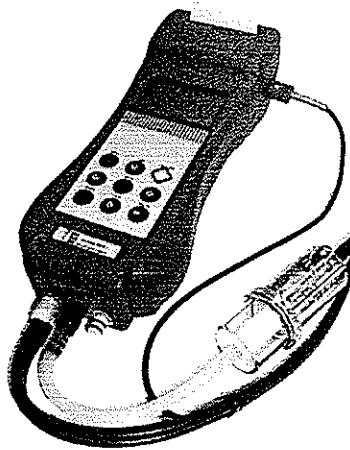

- Press [STORE] to memory store the pressure and draft values.

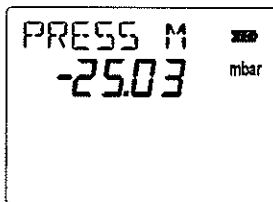

- Press [STORE] to repeat the measurement.
- Press [ESC] to return to the measuring page.

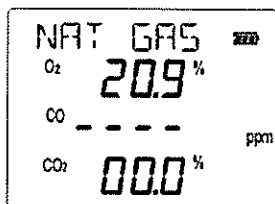

6.1.4.1 Burner pressure measurement

Using the burner pressure probe (cat. EE300088), it is possible to measure the pressure on the burner. Connect the probe to the GreenLine pressure input and connect to the burner plug. Follow the procedure described in the previous paragraph to perform the measure.



6.2 Smoke measurement

To avoid condensation inside the smoke pump, the pump should aspirate ambient air before the gas sample. This can be obtained aspirating the air by the fireside (not in the exhaust gas connection pipe) without using the paper filter. Introduce now the filter in the pump.

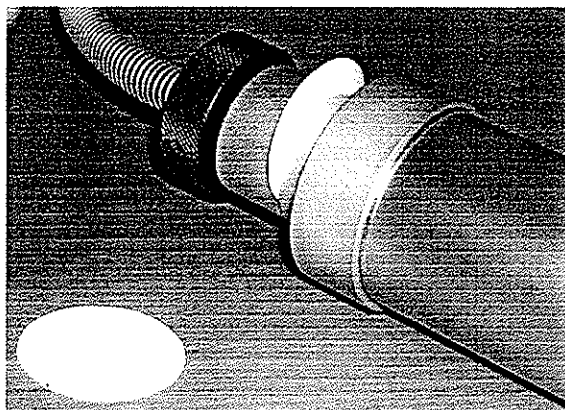

The gas sample should be drawn to the centre of the combustion gas flux. The correct gas volume is sampled with 10 uniform shoots by the pump. We suggest using a retaining cone during gas sampling. Compare the darkening of the filter with the smoke index comparing table. The smoke index found should not exceed the ones defined by the current normative.



6.2.1 Input of the smoke index

Before input the data, you have to execute the smoke index measurements. You can input up to 3 values; the Analyzer will make the average calculus.

These values will be printed on report with the other gas analysis data.

- Press the [MENU] key until the following page will be displayed:

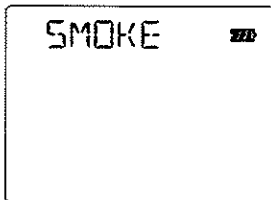

- Press [ENTER] to input the smoke index values.
- Change the value of 1st test by pressing the [▲] and [▼] keys. Press the [ENTER] key to store the value and input the test 2 value.
- Change the value of 2nd test by pressing the [▲] and [▼] keys. Press the [ENTER] key to store the value and input the test 3 value.
- Change the value of 3rd test by pressing the [▲] and [▼] keys.

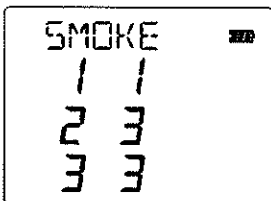

- Press the [ENTER] key to store the value.

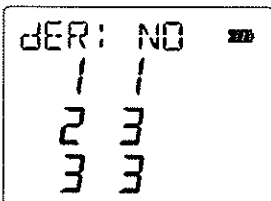

- Press the [▲] key to change the fuel specification.
- Press the [ENTER] key to store the value.
- Press [ESC] to return to the measure page.

6.3 Analysis data print

GreenLine 2000 has two different possibilities to print the flue gas analysis data. You can use the optional internal impact printer or the standard IR port for your HP 82240B wireless thermal printer.

6.3.1 Built-in printer (option)

You can order the GreenLine 2000 complete with an internal 24 column impact printer. The printer is integrated with the instrument and the same batteries of the Analyzer supply the power. The impact model gives you one more advantage: more readability and long time duration on your documents.

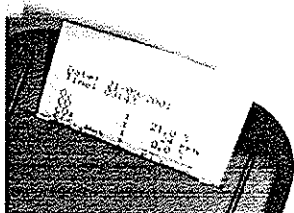

To print the data analysis follow the procedure:

- Wait for the stabilization of the measure on the display. Press the [PRINT] key.
- The display shows the last setting for number of copies to be printed and the document format.
- Check that the internal printer is enabled. Press the [MENU] key and verify that it displays the "PRINTINT" message.
- If you do not need any changes press the [PRINT] key again. The instrument will print the report as programmed
- If you need any changes, read the procedure on paragraph 6.3.3.
- Press [ESC] to return to the measuring page.

6.3.2 External printer

GreenLine 2000 has a standard IR port compatible with your HP 82240B wireless thermal printer. The printer is external to the instrument and the power supply is separated from the Analyzer. No connection cables are necessary: you can near the printer IR led to the IR led of the Analyzer.

To print the analysis data follow the procedure:

- Wait for the stabilization of the measure on the display. Press the [PRINT] key.
- The display shows the last setting for number of copies to be printed and the document format.
- Check that the internal printer is enabled. Press the [MENU] key and verify that it display the "PRINTEXT" message.
- If you do not need any changes press the [PRINT] key again. The instrument will print the report as programmed
- If you need any changes, read the procedure on paragraph 6.3.3.
- Press [ESC] to return to the measure page.

6.3.3 Printer setting

From the printer menu you can change the printer setting: the format of the report (short or complete form), the printer enabled (internal or external) and the number of the copies. From this menu you can also perform the form feed also.

- Press the [PRINT] key to enter in the printer menu.
- The display shows the last setting for number of copies to be printed and the document format.
- Press the [MENU] key until the parameter to be changed is displayed.
- Press the [▶] key to change the value of the displayed parameter. Press the [ENTER] key to store the changes.
- Press the [MENU] key to change the parameter.
- Press the [PRINT] key to print the report.
- Press [ESC] to return to the measure page.

6.3.4 Header setting

Using the GreenLine keyboard, you can set the report header (4 text rows of 16 char each) with your data. Adopt the following procedures:

- Press the [MENU] key from measuring page until the following page is displayed:

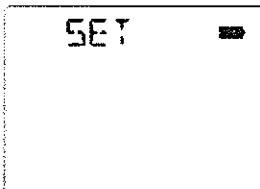

- Press the [ENTER] key. Press the [MENU] key until the following page is displayed:



- Press the [ENTER] key. A number "1" on display will show you that you are changing the first line of the header.
- Press the [▲] and [▼] keys to change the first of 16 character of the header row.

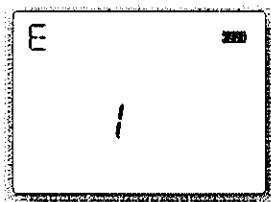

- Press the [◀] and [▶] keys to change the cursor position and change another character.

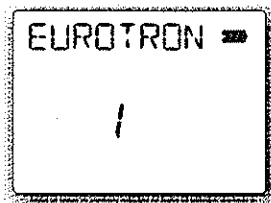

- Press the [ENTER] key to confirm the row inputs and change the second row.

Repeat the previous procedure to change the other header rows.

- Press [ESC] to return to the menu page.
- Press [ESC] to return to the measure page.

6.4 Pressure decay procedure (option)

This optional operative mode allows you to perform Gas network leak test with pressure decay procedure. Before starting the test you have to isolate and to empty the gas network section to be tested.

CAUTION

BE SURE TO EMPTY AND CLEAN THE CIRCUIT: OVERPRESSURE, DUST, LIQUID AND CONDENSING MAY DAMAGE THE GREENLINE INTERNAL CIRCUITS.

CAUTION

A +300HPA (OR -300HPA) OVER-PRESSURE CAN PERMANENTLY DAMAGE THE PRESSURE SENSOR.

To perform the leak test, press the [MENU] key from measuring page.

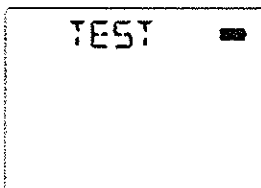

- Press the [ENTER]. Press the [MENU] key until the following page will be displayed:

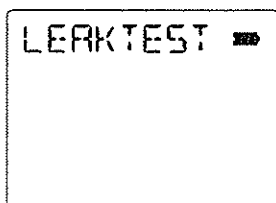

- Press the [ENTER] key to display the following page:



*Example:
Network type:
Length: 10 meters
Diameter: ½ "*

- Change the network type by pressing the [▲] and [▼] keys. Press the [ENTER] key to store the value and input the network length.
- Change the network length by pressing the [▲] and [▼] keys. Press the [ENTER] key to store the value and input the network diameter.
- Change the network diameter by pressing the [▲] and [▼] keys.
- Press the [ENTER] key to store the values and to display the following page:

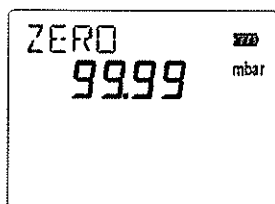

- Press the [STORE] key for sensor offset zeroing.
- Connect the P1 pressure input to the network. Apply a small pressure (lower than 100 hPa) to the network. Pressurize the circuit by using air or inert gases (e.g. Nitrogen).
- Press the [ENTER] key to start the test procedure.

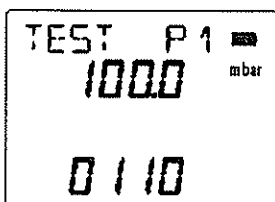

The instrument will display the pressure applied to the P1 input and the remaining time to end of the procedure. The following paragraph will show you how to change this value (std = 300 secs).

When the procedure is finished, the instrument will display the total leak in the network.

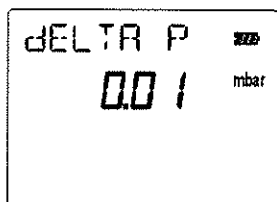

Press the [PRINT] key to print the leak results.

6.4.1 Leak constant set-up

The total leak time testing period is the sum of four different tests constant. The following procedure will show you as to change these values.

- Switch the instrument off.
- Switch the instrument on by pressing the [PRINT] and [ON/OFF] simultaneously.
- DO NOT change the "AUTOZERO" value (it should be 180 secs). Press the [ENTER] key to select the next parameter.
- The display will show the P1 time constant (standard = 10 sec.). Press the [▲] and [▼] to change the value. Press the [ENTER] key to store the value and display the next parameter.
- The display will show the P2 time constant (standard = 60 sec.). Press the [▲] and [▼] to change the value. Press the [ENTER] key to store the value and display the next parameter.
- The display will show the P3 time constant (standard = 120 sec.). Press the [▲] and [▼] to change the value. Press the [ENTER] key to store the value and display the next parameter.
- The display will show the P4 time constant (standard = 120 sec.). Press the [▲] and [▼] to change the value. Press the [ENTER] key to store the value and display the next parameter.
- DO NOT change the "BAUDRATE" value (standard = 9600 baud). Press the [ENTER] key to store the value and display the first parameter.
- Switch the instrument off.

6.5 Ambient CO monitoring

GreenLine 2000 allows ambient CO monitoring for personnel safety. Two different sensor types can be used to perform this function: an external probe or an internal sensor (the CO electrochemical sensor installed for flue gas analysis). The unit emits an acoustic and visible signal if the programmed limit is reached.

The following page shows the current exposure limits for CO gas. This table is a guide only, and the figures must be checked before being used. Sensors used in safety applications should be fully calibrated at least every six months.

	U.K. HSE	GERMANIA DFG	USA OSHA
TWA (8h)	50	30	35
STEL (10')	300	60 (30)	200

WARNING

SENSORS USED IN SAFETY APPLICATIONS SHOULD BE FULLY CALIBRATED AT LEAST EVERY SIX MONTHS.

6.5.1 External CO probe (option)

This optional external probe allows ambient CO monitoring for personnel safety. When connected to the GreenLine analyzer, it monitors continuously CO concentration and it signals when the Long-term Exposure (TWA) limits are reached.

To perform the test, press the [MENU] key from measuring page.

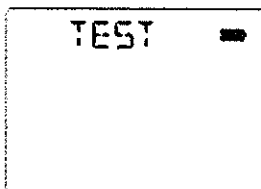

- Connect the probe to the instrument.
- Press the [ENTER]. Press the [MENU] key until the following page will be displayed:

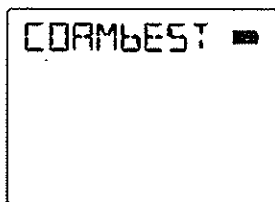

- Press the [ENTER] key to initialise the external probe.

NOTE: WHEN PROBE IS CONNECTED GREENLINE BEGIN A 30 SECONDS WAITING TIME.

Before insert the probe in the working area, agitate it for some seconds in fresh and uncontaminated air. From this moment the unit will compare the monitored value with the CO limit (default OSHA limit: 35ppm). It is possible to change the CO limit using the GasConfig software for PC.

- Press [ESC] to return to the measure page.

NOTE: IF THE PROCEDURE ABOVE IS EXECUTED AND THE CO PROBE REMAINS CONNECTED, GREENLINE WILL MONITOR THE AMBIENT CO ALSO DURING OTHER OPERATIVE MODE.

If the alarm condition is marked, press the [ENTER] key to silence it.

6.5.2 Internal CO sensor

This operative mode needs the internal CO sensor installed (the CO installed for flue gas analysis). It allows the ambient CO monitoring for personnel safety. When this function is active, the instrument monitor continuously CO concentration and it signals when the Long-term Exposure (TWA) limits are reached.

- Remove any pneumatic connection from the **GreenLine 2000** gas INLET.
- To perform the test, press the [MENU] key from measuring page.

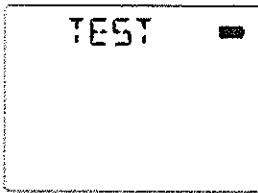

- Press the [ENTER]. Press the [MENU] key until the following page will be displayed:

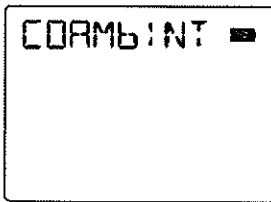

- Press the [ENTER] key to monitor ambient CO.

Wait for 30 seconds sensor zeroing countdown. Before inserting the instrument in the working area agitate it for some seconds in fresh and uncontaminated air.

From this moment the unit will compare the monitored value with the CO limit (default OSHA limit: 35ppm). It is possible to change the CO limit using the GasConfig software for PC.

If alarm condition is marked, press the [ENTER] key to silence it.

NOTE: AMBIENT CO MONITORING IS ACTIVE ONLY ON "COAMBINT" OPERATIVE PAGE.

- Press [ESC] to return to the measure page.

6.6 Gas network leak test (option)

6.6.1 External natural gas leak probe

To enable natural gas monitoring connect the optional external probe to the instrument.

- To perform the test, press the [MENU] key from measuring page.

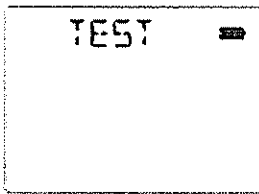

- Press the [ENTER]. Press the [MENU] key until the following page will be displayed:

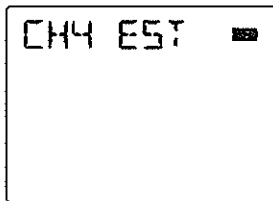

- Press the [ENTER] key to monitor gas concentration.

NOTE: WHEN PROBE IS CONNECTED GREENLINE BEGINS A 50 SECONDS HEATING TIME.

Before inserting the probe in the working area, agitate it for some seconds in fresh and uncontaminated air. From this moment the unit will display the gas concentration.

- Press [ESC] to return to the measure page.

6.6.2 Internal natural gas leak sensor

This operative mode needs the internal gas sensor installed. It allows natural gas monitoring for gas network leak test.

- Remove any pneumatic connection from the GreenLine 2000 gas INLET.
- To perform the test, press the [MENU] key from measuring page.

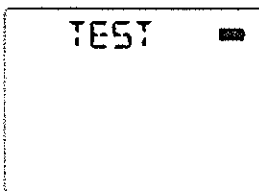

- Press the [ENTER]. Press the [MENU] key until the following page will be displayed:

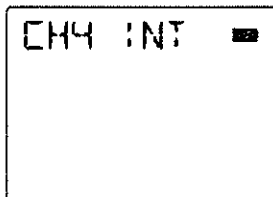

NOTE: WHEN PROBE IS CONNECTED GREENLINE BEGINS A 50 SECONDS HEATING TIME.

Before inserting the instrument in the working area, agitate it for some seconds in fresh and uncontaminated air. From this moment the unit will display the gas concentration.



- Press [ESC] to return to the measure page.

7 MEMORY MANAGEMENT

The standard configuration includes an internal memory to store up to 1000 complete gas analysis divided by Tags (max. 40 tags). Each analysis includes the gas concentration values, data and time. Each Tag includes one or more analysis data, 16 characters ID, 3 rows for the Customer data, Draft and smoke index values, etc.

7.1 Store data analysis

- Press the [STORE] key to enter in memory management menu.
- Select the desired Tag [▲] and [▼] until it is displayed.
- Press the [STORE] key to memory store the gas analysis data.

The complete analysis data are stored in the internal memory complete with data and time. You can recall and print them any time you need.

- Press [ESC] to return to the measure page.

7.2 Delete all data

WARNING

THIS OPERATION WILL DELETE PERMANENTLY ALL THE MEMORIZED MEASUREMENTS IN THE INSTRUMENT.

- Press the [STORE] key to enter in memory management menu.
- Press the [MENU] key to display the "DELETE" message.
- Press the [ENTER] key to delete all memory data in gas Analyzer.
- Press [ESC] to return to the measure page.

7.3 Recall single data

- Press the [STORE] key to enter in memory management menu.
- Select the desired Tag [▲] and [▼] until it is displayed.
- Press the [MENU] key to display the "SINGLE" or "AVERAGE" message.
- Press the [▲] until the "SINGLE" message is displayed.
- Press the [MENU] key to display the "RECALL" message.

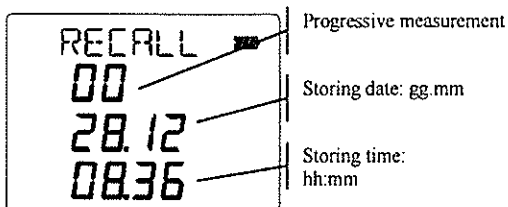

- Press the [◀] and [▶] keys to display the desired analysis.
- Press the [ENTER] key to display the data.

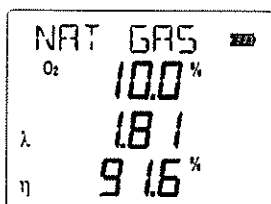

- Pressing the [◀] and [▶] keys you can change page to display other parameters.
- Press the [PRINT] key to print the data.
- Press [STORE] to go to the previous page.
- Press [ESC] to return to the measure page.

7.4 Recall average data

- Press the [STORE] key to enter in memory management menu.
- Select the desired Tag [▲] and [▼] until it is displayed.
- Press the [MENU] key to display the "SINGLE" or "AVERAGE" message.
- Press the [▲] until the "AVERAGE" message is displayed.
- Press the [MENU] key to display the "RECALL" message.

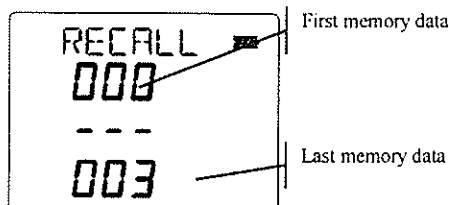

- Press the [ENTER] key to display the data.
- Press the [PRINT] key to print the data.
- Press [STORE] to go to the previous page.
- Press [ESC] to return to the measure page.

7.5 RS232 Serial interface set-up

GreenLine 2000 is enabled for RS232 bi-directional serial communication. An optional adapter cable (cat. BBxxxxxx) can be included for PC connection.

Before starting the data transfer, you need to check and eventually to change the baud rate to be sure that the PC and GreenLine have the same communication speed.

Adopt the following procedure:

- Switch the instrument on pressing simultaneously [PRINT] + [ON/OFF] keys.
- Press the [ENTER] key until "BAUDRATE" parameter is displayed.
- If needed, change the "BAUDRATE" (standard = 9600 baud) pressing the [▲] and [▼] keys. Available speeds are: 9600, 19200, and 38400 baud.
- Press the [ENTER] key to store the changes.
- Switch the instrument off.

7.6 DBGas 2000 software

DBGas 2000 is a PC Windows 95/98/NT compatible program to manage all checks and measures activities on boilers and to transfer data from and to Eurotron Gas analyzers. The software is designed for a complete and efficient managing and recording of the analysis data of your clients. **DBGas 2000** allows you to have a no limits database on your PC with all customer and boiler information, to select up to 40 boilers to be checked, to assign an operator name and transfer the data to the analyzer. The operator can memory store up to 250 boiler checks and print the report; after the analysis he can transfer the data to the PC. The software will assign the analysis to the correct boiler in the database. Operator can view and print the data until he deletes these.

The main menu is made of 4 buttons: Plants/Clients, Analysis, Fuels and Exit from program.



7.6.1 Plants/Clients menu

Selecting this option, you can manage the customers, boilers and plants information database and it is possible to transfer this data from the PC to the analyzer. For each plant the customer personal data can be assigned (name, address, phone and fax numbers, etc.) and one or more boiler information (name, type, fuel, etc.). Database is organized as a two separate tables: Plants/Clients database and Boilers installed.

Selecting one plant on the upper table, the lower table will show you the boilers installed on that plant.

All data can be changed easily by clicking with the mouse pointer on the cell. You can input the new data on the blank row (the last one) for adding a new boiler or new plant record. To delete a boiler or a plant you have to select it with a click and press the "Delete" key on PC keyboard.

To have a more readable database, you can reduce, enlarge or hide the columns; approach the mouse pointer to the right limit of the cell to be reduced (enlarged), pressing the right button move the mouse to the left (right). By pressing two times quickly the left mouse button on the column, this will be automatically adapted to the pre-set dimensions. All changes will be saved when you exit from the program.

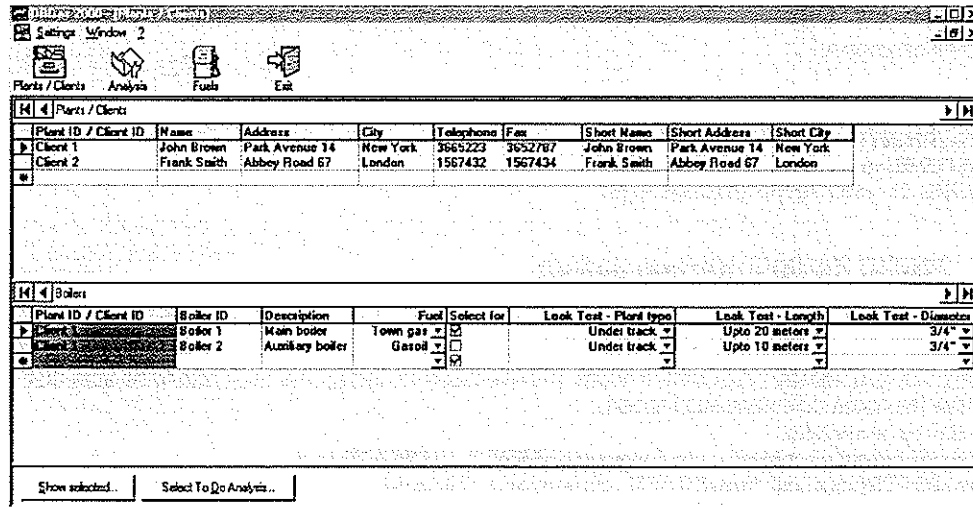

When database is completed, you can select up to 40 boilers on the table for data transfer by selecting the "Select for data transfer" column. Pressing the "Select to Do Analysis", you can select in automatic mode all analysis made by more than "XX" months.

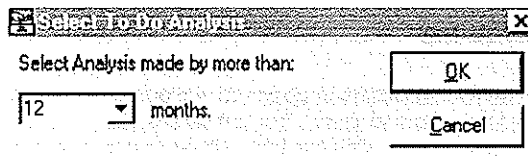

Pressing the "Show selected" button, the program will show all boilers selected for data transfer.

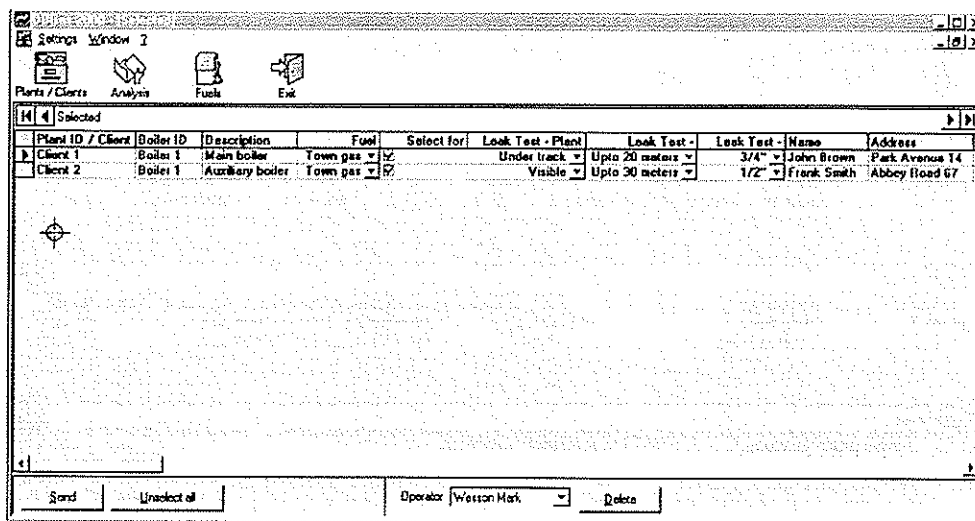

You can exclude manually one or more boilers from the list. Select or input the operator's name, connect the IR to RS232 adaptor to the PC, approach the IR terminal to the analyzer IR communication windows, and press the "Send" button to send the data to the analyzer.

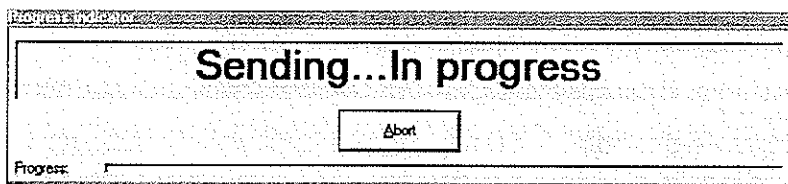

7.6.2 Analysis menu

This option is the main part of the program. You can transfer the analysis data from the Analyzer to the PC, save and manage it using a database structure, display and export the data in Microsoft Excel™ compatible format. The analysis window is made of 3 tables: plant and customer information, boiler information for the selected plant and analysis group's data for the selected boiler. The analysis group's data will be ordered by data and will show the general data for the group of measurements (smoke indexes, T flow and return, etc.).

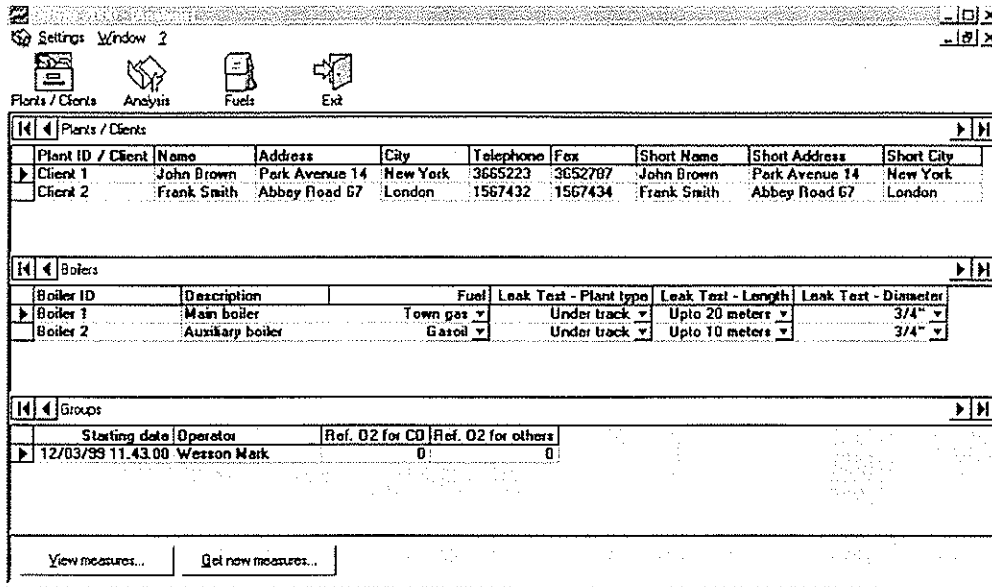

Select with the mouse the Plant, Boiler and Group to be displayed. The arrows on the left column on the tables will show you the current record. Pressing the "View measure" button you can read the single data measurements for the selected group (contents of gas, temperatures, pressure/draught, efficiency, smoke index, etc).

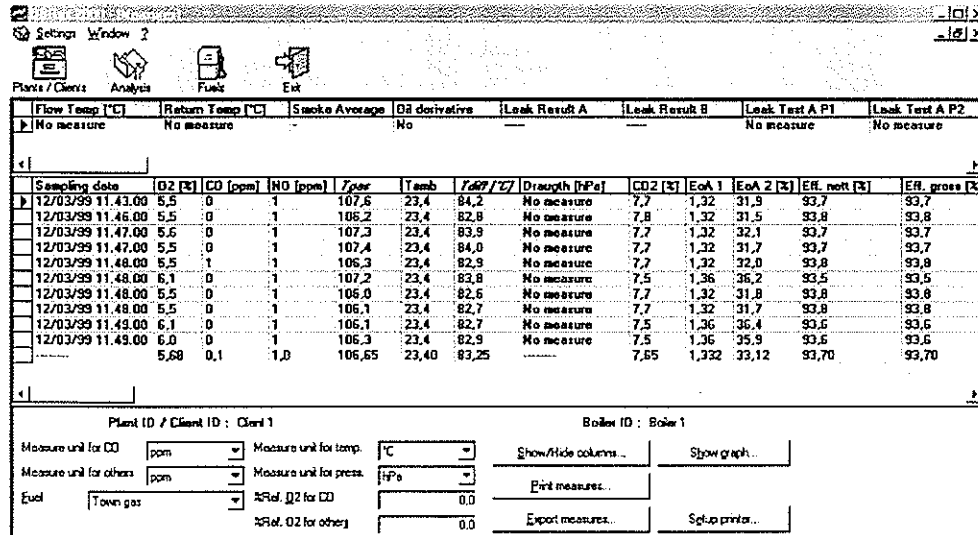

The operator can change the measuring units, the fuel type, etc. The program will made the conversion in real time and will display the new values.

A set of 4 buttons allows you to set the printer, to print measures, export measures using an Excel compatible format, show or hide the columns.

A fifth button is normally disabled and it allows displaying graphics. To display a graph, you have to select one or more columns for graphics. Select the column by positioning the mouse pointer on the desired column header and click, using the mouse left button; click using the mouse right button and select the "Select for graph" option. The column header will be displayed in *italic*. The "Show graph" button becomes active. You can display the graph by pressing the "Show graph" button.

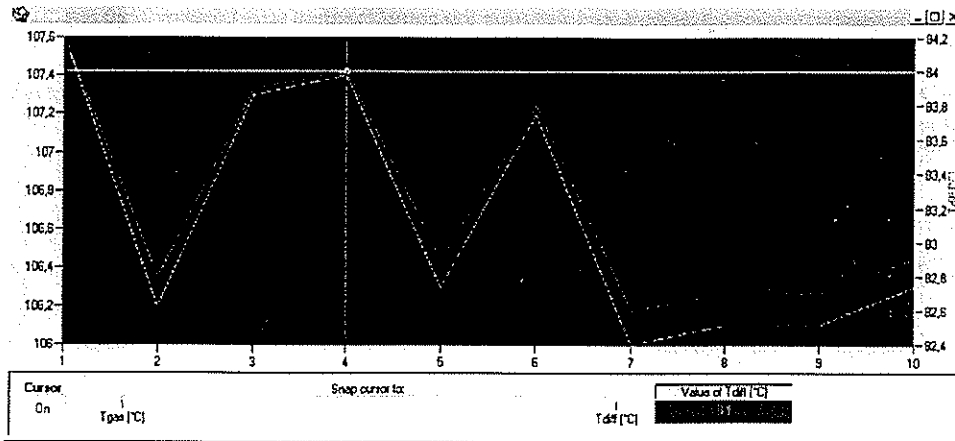

Activate the cursor and snap cursor to the desired parameter. Using the mouse you can move the cursor amongst the measure.

7.6.3 Fuels menu

You can read from the analyzer all data parameters for the stored fuels. Press the "read from instrument" button to transfer, using the IR interface, the fuel data from the analyzer.

#1	#2	#3	#4	#5	#6	#7	#8	#9
Fuel name		Town gas						
K1/K/A/C	0.5800	Knett	0.000					
K2/B/D	0.0000	H	0.0					
KL	0.89	mH2Q	0.0					
CO2MAX	10.5	Qgross	0.00					
EGJ	0.2304	Qnett	0.00					
Kgross/H/Hg	0.0000	Formula type	Siegertsche					

Get from instrument Close

NOTE: THE FUEL DATA TRANSFER FROM ANALYZER SHOULD BE MADE AFTER THE PROGRAM INSTALLATION OR IF THE FUEL DATA CHANGES ON GREENLINE ANALYZER.

IMPORTANT

TO CHANGE OR ADD NEW FUELS DATA, YOU HAVE TO USE GASCONFIG SOFTWARE. THE INSTRUCTIONS ARE SHOWN ON PARAGRAPH 8.6.

7.6.4 DBGas 2000 Installation

DBGas 2000 runs on IBM PC under WINDOWS 95/98/NT. Minimum requirements are a Pentium CPU with 16Mbyte Ram and 20 Mbyte on hard disk, a colour monitor and a Microsoft mouse or a compatible one.

In order to install DBGas 2000 for Windows, follow the below procedure:

- Place the DBGas 2000 disk in a CD-ROM drive;
- From the Windows Start Menu, select <RUN>;
- Enter the filename D:SETUP.EXE (substitute the letter D for the disk drive that contains DBGas 2000 disk)



- Follow the on screen instructions making sure to provide the correct path to your **DBGas 2000** directory when prompted.

Once installed, the **DBGas 2000** icon will appear on your Windows screen and it will be possible to boot it by clicking on the icon as usual.



8 CONFIGURATION

8.1 Engineering Units

You can change, directly from the keyboard, the engineering unit for the measured parameters.

Gas concentration available units are: ppm, mg/m³, mg/kWh.

Temperature available units are: °C, °F.

Pressure available units are: hPa, mbar, Pa, mmH₂O, inchH₂O.

Adopt the following procedures:

- Press the [MENU] key from measuring page until the following page is displayed:

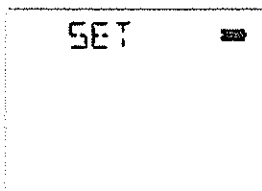

- Press the [ENTER]. Press the [MENU] key until the following page is displayed:

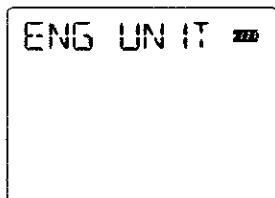

- Press the [ENTER] key to change the unit for the CO parameter.

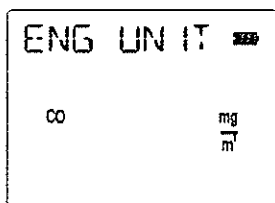

- Press the [▲] key to select one different unit.
- Press the [ENTER] key to store the changes and to modify the temperature unit.

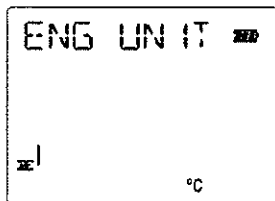

- Press the [▲] key to select one different unit.
- Press the [ENTER] key to store the changes and to modify the pressure unit.

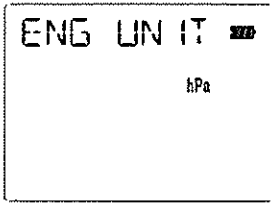

- Press the [▲] key to select one different unit.
- Press the [ENTER] key to store the changes.

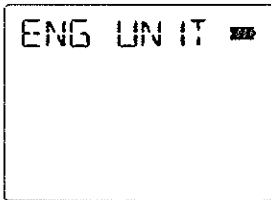

- Press [ESC] to return to the measure page.

8.2 Alarms

You can set up to 3 alarms related to 3 different (O₂, CO, and Tair) measured parameters.

Adopt the following procedures:

- Press the [MENU] key from measuring page until the following page is displayed:

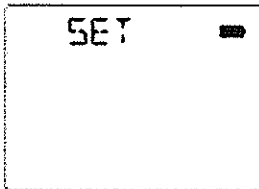

- Press the [ENTER]. Press the [MENU] key until the following page is displayed:



- Press the [ENTER] key to change the O₂ alarm level.

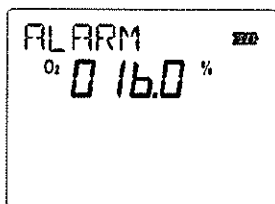
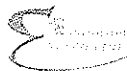

- Press the [▲] and [▼] keys to change the flashing digit. Press the [◀] and [▶] keys to select a different digit.
- Press the [ENTER] key to store the changes and modify the CO alarm level.

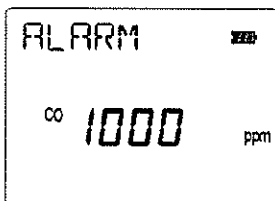

- Press the [▲] and [▼] keys to change the flashing digit. Press the [◀] and [▶] keys to select a different digit.
- Press the [ENTER] key to store the changes and modify the Tair alarm level.

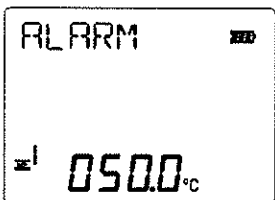

- Press the [▲] and [▼] keys to change the flashing digit. Press the [◀] and [▶] keys to select a different digit.
- Press the [ENTER] key to store the changes.

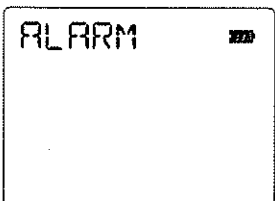

- Press [ESC] to return to the measure page.

When one of the alarm levels is more than the reading, the Analyzer generates a continuous beep. Press the [ENTER] key to mute the instrument.

8.3 Measure related to Oxygen percentage

Directly from the instrument keyboard, it is possible to set the Reference Oxygen percentage for CO measurements. The normative related with your application will give you the correct value to input. The analysis printed report carries both measured and calculated CO values.

Pressing the [REF. O₂] key the CO measured parameter will be displayed as referred to the programmed oxygen value. When selected this mode, the message "REF O₂CO" will be displayed.

Adopt the following procedure:

- Press the [MENU] key from measuring page until the following page is displayed:

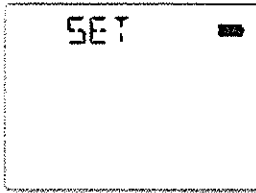

- Press the [ENTER]. Press the [MENU] key until the following page is displayed:



- Press the [ENTER] key to change the O₂ percentage.



- Press the [▲] and [▼] keys to change the flashing digit. Press the [◀] and [▶] keys to select a different digit.
- Press the [ENTER] key to store the changes.

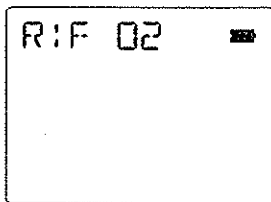

- Press [ESC] to return to the measure page.

8.4 Clock set-up

Adopt the following procedure:

- Press the [MENU] key from measuring page until the following page is displayed:

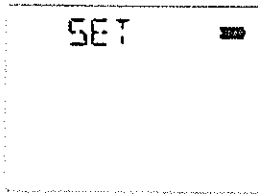

- Press the [ENTER]. Press the [MENU] key until the following page is displayed:

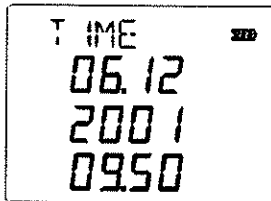

- Press the [ENTER] key to enter in set-up mode.
- Press the [▲] and [▼] keys to change the flashing digit (Day). Press the [ENTER] key to store the changes.
- Press the [▲] and [▼] keys to change the flashing digit (Month). Press the [ENTER] key to store the changes.
- Press the [▲] and [▼] keys to change the flashing digit (Year). Press the [ENTER] key to store the changes.
- Press the [▲] and [▼] keys to change the flashing digit (Hour). Press the [ENTER] key to store the changes.
- Press the [▲] and [▼] keys to change the flashing digit (Minutes). Press the [ENTER] key to store the changes.
- Press [ESC] to return to the measure page.

8.6 Configuration Software

GasConfig software is a PC windows compatible program for configuring GreenLine flue gas analyzers. You can change all memory settings: displayed measurements pages, printed measurements layout, Alarms, Fuels coefficients, measuring technical units, etc.

8.6.1 GasConfig Installation

The Software runs on IBM PC under WINDOWS 95/98/NT operative systems. Minimum requirements are a Pentium CPU with 16Mbyte Ram and 8 Mbyte on hard disk, a colour monitor and a Microsoft mouse or a compatible one. In order to install the Software for Windows, follow the below procedures:

- Place the Software disk in a CD-ROM drive;
- From the Windows Start Menu, select <RUN>;
- Enter the filename D:SETUP.EXE (substitute the letter D for the disk drive that contains Software disk)
- Follow the on screen instructions making sure to provide the correct path to your Software directory when prompted.

Once installed, the **GreenLine Configuration Software** icon will appear on your Windows screen and it will be possible to boot it by clicking on the icon as usual.

8.6.2 How operate using GasConfig

When you run GasConfig a 2 independent windows system will be displayed on the PC monitor.

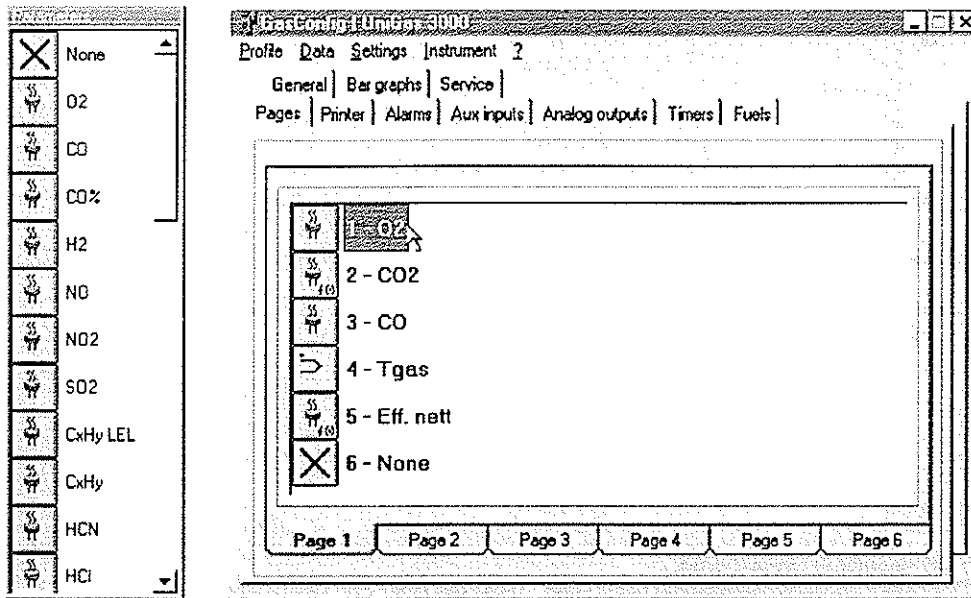

The window on the left is a parameter icon list. This list shows all possible parameters to measure (O₂, CO, Tgas, Draught, etc.) and calculate measures (CO₂, Efficiency, etc.). Some of these may not be available in your instrument (it depends by instrument model, installed cells, and options).

The window on the right is the program user interface. It is organized in function pages; you can select the page for interested parameters using the mouse. A main menu bar allows you to load and save the configuration data, to change communication setting, for data transfer to and from the analyzer.

WARNING

BEFORE CONFIGURATION DATA TRANSFER TO AND FROM YOUR PC, BE SURE TO HAVE SELECTED THE GREENLINE UNIT USING THE "INSTRUMENT" OPTION ON MAIN MENU BAR.

The available function pages are:

- General** This page allows you to set the general parameters as engineering units, O₂% reference values, etc.
- Pages** You can set up to 6 different pages in your GreenLine to display up to 36 different measured and calculated values.
- Printer** You can program the complete layout for report printing: header, measured parameters, etc.

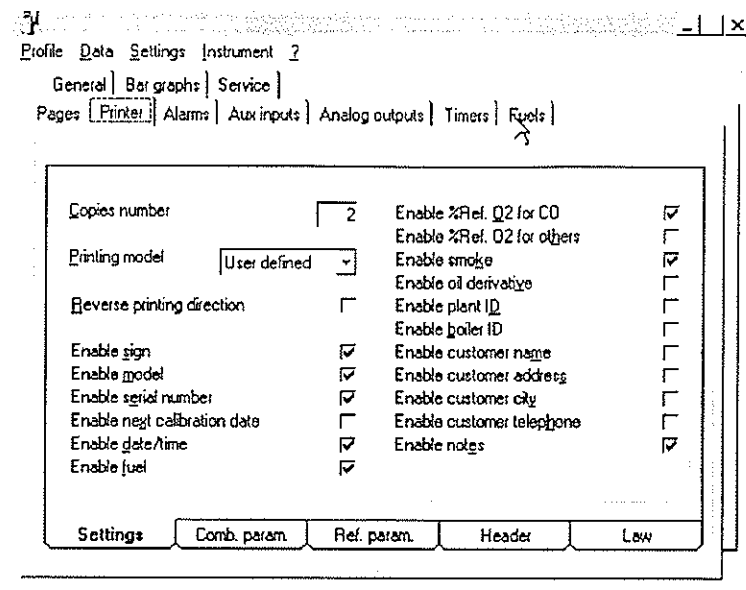

Alarms

You can enable, disable, and program up to 4 different acoustic and visible alarms for critical measurements.

Aux Inputs

Not available for software version 1.001

Analogue Output

Not available for software version 1.001

Timer

You can change the autozero time and the leak decay time.

Fuels

Up to 10 different fuels coefficient tables can be programmed.

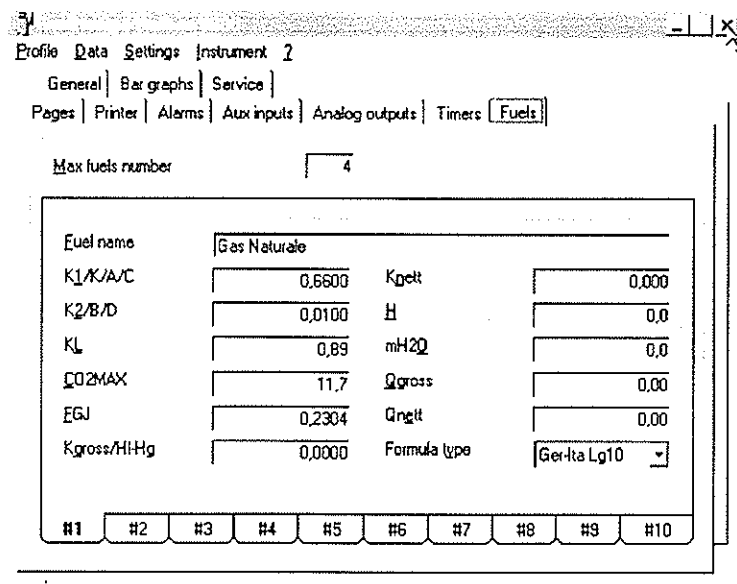

Bar graphs

You can set up to 6 different bargraph (parameter and range).

Service

3 services information lines can be programmed for factory co-ordinates. (We suggest having Eurotron telephone and faxing numbers).

9 MAINTENANCE

GreenLine 2000 analyzer has been developed and manufactured using high quality components. A correct systematic maintenance will prevent damage and will increase substantially the life of the instrument, giving excellent results. Anomalous conditions that require extraordinary maintenance interventions are promptly displayed, either clearly or with an information code.

9.1 Printer maintenance

Open both the covers pressing as in figure, to change the paper and/or the ribbon.

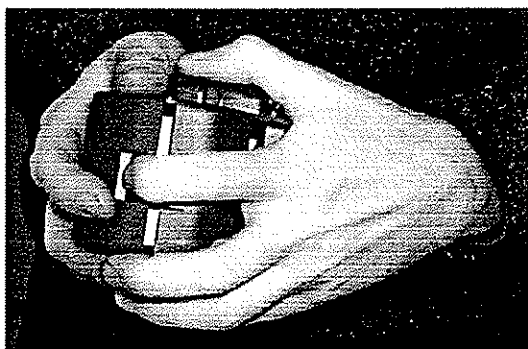

Extract the exhausted paper roll. You can use standard paper roll but you have to check before for its dimensions (max. 57mm \pm 1mm large).

If necessary substitute the ribbon cartridge (cod. EE490002).

Approach the end of the new paper roll (cod. EE340006) to the slot under the printer.

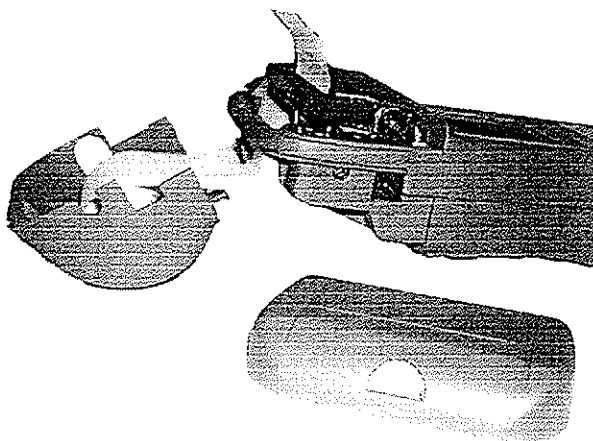

Switch the analyzer on.

Press the [PRINT] key down; press the [MENU] key until the "FEED" message is displayed.

Press [ENTER] for paper feed. Press the [ESC] key when the paper will come out for some centimetres.

Close the cover inserting the paper end in its slot.

9.2 Firmware Upgrade

In order to upgrade the firmware of the GreenLine instrument proceed as follows:

- 1 - Install the ST167Flash program from the CD.



- 2 - Connect the infrared interface adapter to the serial port of the PC with the supplied cable (note back the serial port used: COM1 , COM2 or other).
- 3 - Connect the interface to the instrument.
- 4 - Run the ST167Flash program you have installed.
- 5 - Select the same serial port that you noted back.
- 6 - Select the Baud rate to 115200 Baud (if the PC owns an UART 16550 type), otherwise select a lower Baud rate.
- 7 - Press the three dotted button in order to load the firmware file (.HFW extension) normally located on a 3 1/2" diskette. A version number of the firmware being discarded is shown in the dedicated field.
- 8 - From instrument OFF press and continue to press the F1 key while pressing the ON/OFF key in order to set the instrument in firmware upgrade status.
- 9 - Click on the 'Program' button to start the upgrading phase and wait until a termination message appears.

NOTE: IF DATA TRANSFER FAILS, PLEASE TURN OFF THE INSTRUMENT AND REPEAT THE PROCEDURE FROM STEP 8.

9.3 Smoke pump maintenance

Gas-tight checking

To have a correct measurement the pump should be gas-tight. Turn the screw and close the probe with your finger. Pull the plunger for 3 cm and verify that the gasket does not leak from the vacuum. If a leak is found the gasket needs to be lubricated. When you push the plunger the valve must close immediately to have a 1.9/2.0 litres of air with 10 shoots. The correct smoke index can be obtained only if the pump works correctly.

Service

1. Clean and lubricate the cylinder the stem and the gasket every 30 measurements.
2. Wash using alcohol if the valve is not gas-tight
3. Clean the probe and the paper support
4. Check the pump for gas-tight
5. Use only clean paper filters and a readable scale index table

9.4 Error messages

GreenLine performs the autodiagnostic procedure when switched on. When measuring it checks also for anomalous conditions. If analyzer finds trouble, it displays an error for the related parameters. Printing the report, the error messages will be printed. Sometimes these messages correspond to an unrecoverable problem and it is necessary to return the instrument to Eurotron for maintenance. Frequently these messages are referred to a recoverable trouble and can be solved by yourself.

The following table shows the possible GreenLine error messages:

Error message	Problem	Solutions
Calc Err	Parameter calculus error.	The instrument cannot perform the calculus. Check and solve the others error conditions.
Probe Er	The external Rtd probe is unconnected or damaged.	Connect or replace the external temperature probe.
RJ Err	Internal temperature reference damaged.	Return the instrument to Eurotron for maintenance
Over	Over range condition	The problem is solved automatically when measure return inside the range
Under	Under range condition	The problem is solved automatically when measure return inside the range
-----	No calculus available	The instrument cannot perform the calculus. Check and solve the others error conditions.

		(e.g. O ₂ >18%).
Excluded	CO sensor excluded by electro-valve	Automatic CO sensor protection is active. Perform one or more autozero cycle in fresh air.
Tc Error	The thermocouple is unconnected or damaged.	Connect or replace the temperature probe.
Tsens Er	Cell compensation error	Return the instrument to Eurotron for maintenance.
Zero Err	The autozero procedure is failed	Perform one or more autozero cycle in fresh air. If the problem remains, Return the instrument to Eurotron for maintenance.
Sens. Er	Broken cell	Return the instrument to Eurotron for maintenance.
No meas.	Empty Memory	
No sens.	The cell is non installed	
No probe	No external probe connected on minidin connector.	Connect or replace the temperature probe.

9.5 Display battery level

- Press the [MENU] key from measuring page until the following page is displayed:

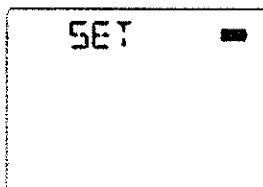

- Press the [ENTER]. Press the [MENU] key until the following page is displayed:

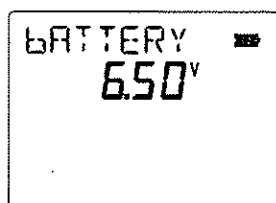

9.6 Accessories and Consumable parts

Accessories

EE300175	magnetic plate
EE880047	Rubber holster with magnetic plate
BB880043	Vinyl carrying case with shoulder strap
BB880028	ABS Rigid carrying case
BB880033	Aluminium carrying case
BB260166	GasConfig + DbGas2000 + ST Flash PC software
EE420280	RS232 adapter cable
BB610041	Manual pump for smoke measurement
BB610057	3 m long extension gas hose

Auxiliary external probes

EE300088	Burner pressure probe
----------	-----------------------



BB830009	External Ambient CO probe
BB830010	External Natural gas checker (Sniffer) probe
BB830018	Remote air sensor+2m cable length+positionning cone
BB830019	External probe for ionization current
EE300088	Pressure connection kit (double hose)

Gas sampling probes

BB610047	180 mm standard max 800°C
BB610051	180 mm standard max 800°C + draft (double hose)
BB610046	300mm standard max 800°C + draft (double hose)
BB610043	90mm 90° probe

Battery Chargers

BB290029	115V 50/60 Hz USA plug
BB290027	230V 50/60 Hz Schuko plug
BB290028	230V 50/60 Hz UK plug
BB290026	230V 50/60 Hz European plug
BB290030	100V 50/60 Hz USA/Japan plug
BB290031	DC auto adapter

Consumable parts

EE340006	Printer paper roll 58 mm x 10 meters long
EE490002	Printer ribbon cartridge
EE650074	Line Filter cartridge for EE650076 water trap
EE860004	Smoke index comparing table
EE650011	Filter for smoke measurement (set of 40 pcs.)
EE650076	Water trap
EE650082	Water trap complete of hose and connector
EE650081	Rubber plug for EE650076 water trap
EE300178	Precalibrated Oxygen sensor kit

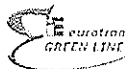

10 CERTIFICATES

10.1 Warranty terms

Each instrument is shipped with a Warranty Certificate that indicates the validity conditions of the warranty itself.

Eurotron guarantees its products against defects in materials and workmanship.

If the unit should malfunction, it must be returned during the warranty period, transportation prepaid, to **Eurotron** for evaluation. Upon examination, if the unit is found to be defective it will be repaired or replaced at no charge.

Eurotron's WARRANTY does not apply to defects resulting from any action of the purchaser, including but not limited to mishandling, improper interfacing, operation outside of design limits, improper repair, or unauthorised modification. This WARRANTY is VOID if the unit shows evidence of having been tampered with or shows evidence of being damaged as a result of excessive corrosion; or current, heat, moisture or vibration; improper specification; misapplication; misuse or other operating conditions outside of **Eurotron's** control.

This warranty applies to the original purchaser only. Please include a copy of the original invoice or a small service charge may be applied.

Direct all warranty and repair requests/inquiries to the **Eurotron** Customer Service Department. **BEFORE RETURNING ANY PRODUCT(S) TO EUROTRON, PURCHASER MUST OBTAIN AN AUTHORIZED RETURN (AR) NUMBER FROM EUROTRON'S CUSTOMER SERVICE DEPARTMENT (IN ORDER TO AVOID PROCESSING DELAYS).**

The purchaser is responsible for shipping charges, freight, insurance and proper packaging to prevent breakage during transit.

10.2 Letter of conformity

Each instrument is shipped with a Letter of Conformity, to grant that the characteristics of the instrument correspond to the required ones and that the instrument calibration is traceable to the National and International Standards.

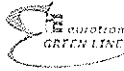

A1 EMC Conformity

The instrument case made in shock-resistant injection moulded ABS + polycarbonate has an internal metal coating to fulfil the provision of the directive 89/336/CEE Electromagnetic Compatibility.
Follow the page with the EMC declaration of conformity



Declaration of Conformity

We : Eurotron Instruments

(Supplier's name)

127 Walters Ave., Trenton, NJ 08638

(Address)

declare under our sole responsibility that the product :

Palmtop flue gas Analyzer mod. GreenLine 2000

(Name and type)

cat. 7822

(Model)

to which this declaration relates is in conformity with the following normative documents :

EN 50082-1 (8/97)

IEC 1000-4-2 / IEC 1000-4-4 / IEC 1000-4-11

ENV 50140 - ENV 50141 - ENV 50204

EN 55011

(Title, number and date of issue of normative documents)

following the prevision of directive :

89/336/CEE Electromagnetic Compatibility (EMC)

December 4, 2001

(Place and date of issue)

(Signature of authorised person)



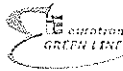

INDEX

- A**
- Accessories; 50
 - Accuracies and ranges; 8
 - Allarms; 42
 - Ambient CO monitoring; 30
 - Analysis data print; 26
 - Analysis menu; 37
 - APPENDIX; 53
 - Auxiliary external probes; 50
 - Auxiliary measure; 14
- B**
- Backlight; 11
 - Built-in printer; 26
 - Burner pressure measurement; 24
- C**
- Calibration certificate; 8
 - CERTIFICATES; 52
 - Chargers; 51
 - Clock set-up; 44
 - ConfiGas Installation; 45
 - CONFIGURATION; 41
 - Configuration Software; 45
 - CONNECTIONS; 17
 - Consumable parts; 50; 51
- D**
- DBGas 2000; 35
 - DBGas 2000 Installation; 39
 - Delete all data; 34
 - Display; 10
 - Display battery level; 50
 - Draft; 14
- E**
- Electromagnetic compatibility; 8
 - Electro-pneumatic connections; 17
 - EMC Conformity; 54
 - Engineering Units; 41
 - Error messages; 49
 - External ambient CO probe; 7
 - External CO probe; 30
 - External gas leak probe; 7
 - External natural gas leak probe; 31
 - External printer; 26
- F**
- Features and Benefits; 5
 - Firmware Upgrade; 48
 - Flue Gas Analysis; 20
 - Fuel technical data; 8
 - Fuel type set-up; 21
 - Fuels menu; 39
 - functional blocks; 12
- G**
- Gas analysis; 19
 - Gas network leak test; 31
 - Gas probe positioning; 17
 - Gas sampling probe; 12; 51
 - Gas sensors; 13
 - GENERAL DESCRIPTION; 7
- H**
- Header setting; 26
 - How operate using ConfiGas; 45
- I**
- Internal CO sensor; 31
 - Internal natural gas leak sensor; 32
- K**
- Keyboard; 9
- L**
- Leak constant set-up; 29
 - Letter of conformity; 52
 - line filter; 12
- M**
- MAINTENANCE; 48
 - Measure related to Oxygen percentage; 43
 - Measurement principle; 12
 - Measuring instruments; 14
 - MEMORY MANAGEMENT; 34
- O**
- OPERATIONS; 19
 - Ordering code; 6
 - Other measurements; 15
- P**
- Paper replacement; 48
 - PHYSICAL DESCRIPTION; 9
 - Plants/Clients menu; 36
 - Power supply; 16
 - Pressure; 14
 - Pressure decay procedure; 28
 - Pressure/Draft measurement; 22
 - PRINCIPLE OF OPERATION; 12
 - Printer maintenance; 48
 - Printer setting; 26
- R**
- Recall average data; 35
 - Recall single data; 34
 - RECOMMENDATIONS; 16
 - Ribbon replacement; 48



RS232 Serial interface set-up; 35

S

Smoke index input; 25
Smoke index measurement; 14
Smoke measurement; 24
Smoke pump maintenance; 49
Specifications; 7
Store data analysis; 34
Switch the instrument ON; 19
Symbols on display; 10

T

Temperature measurements; 14

U

UNI 10389 Fuel coefficients; 8

W

Warranty terms; 52
Water trap; 12
Wireless printer; 5